

# BeoVision Horizon

BeoVision Horizon-40  
BeoVision Horizon-48

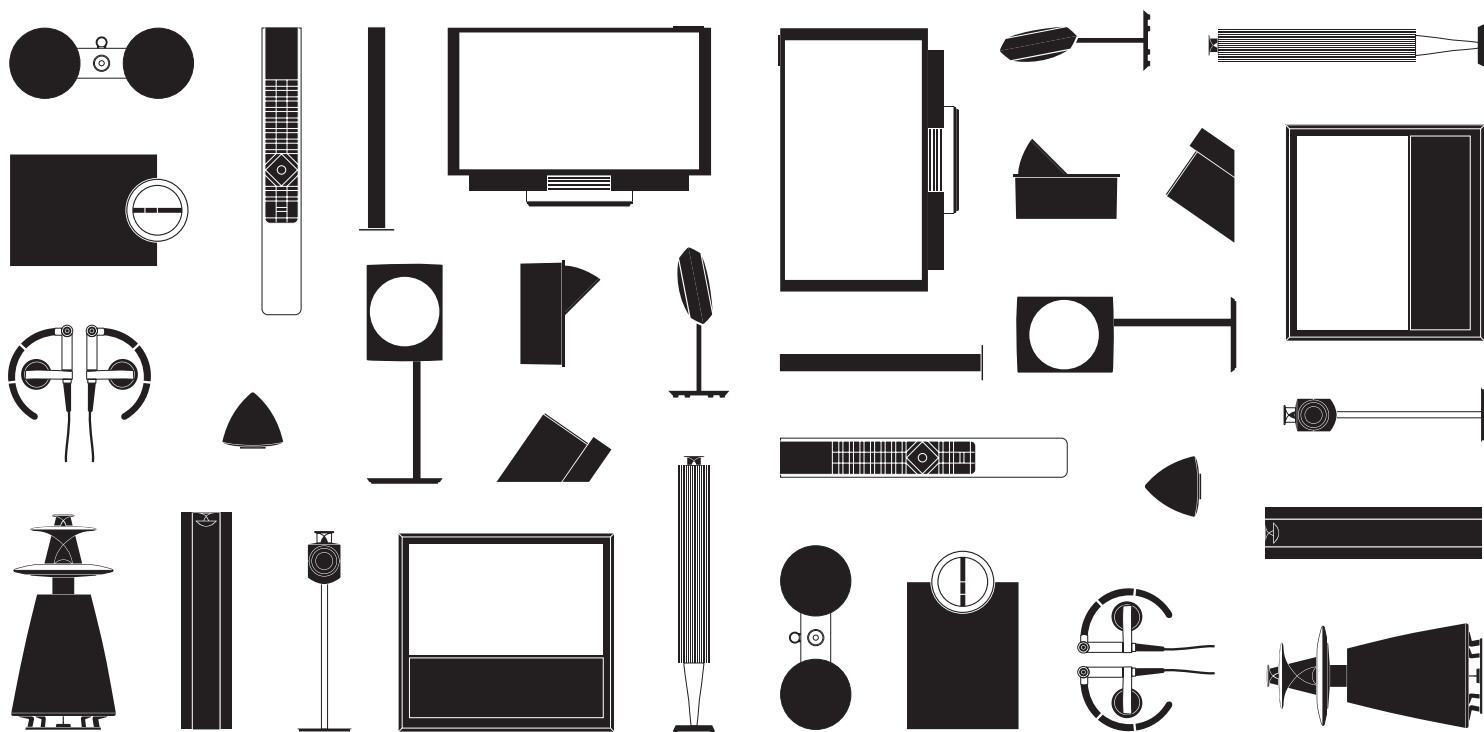

BANG & OLUFSEN

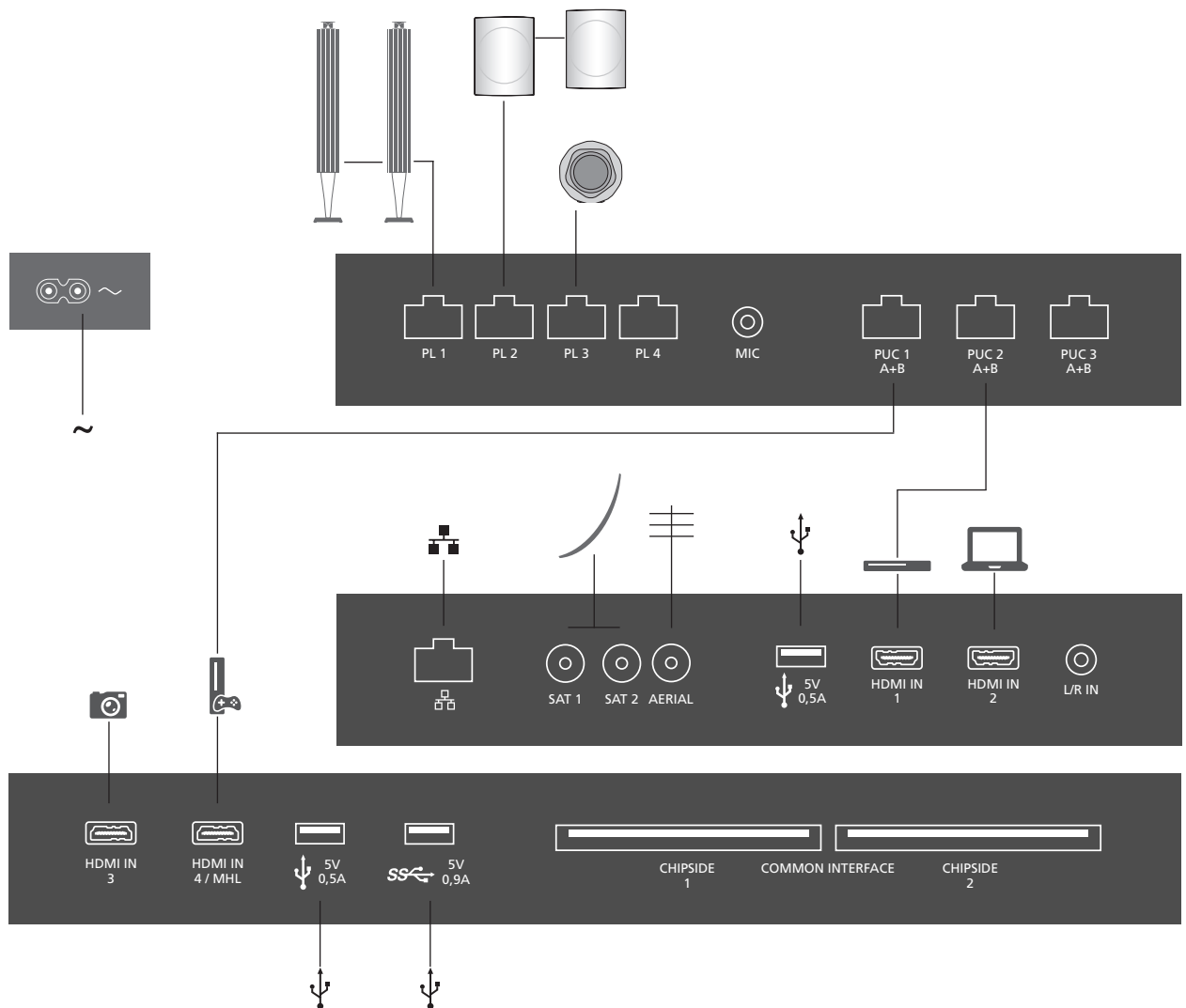

### Cautions

- The product can only be switched off completely by disconnecting it from the mains socket. The mains socket must always be accessible.
- No naked flame sources, such as lighted candles should be placed on the apparatus.
- Follow instructions to ensure correct and safe installation and interconnection of equipment in multimedia systems.
- Make sure the cable connection between the product and the router does not exit the building to avoid contact with high voltage.
- The product label is placed behind the cover for the connection panel.
- Warning! To prevent the spread of fire, keep candles or other open flames away from this products at all times.
- Produktmærkatén sidder bag afdækningen til tilslutningspanelet.
- Advarsel! For at forhindre brand må stearinlys og andre typer åben ild aldrig bruges i nærheden af produktet.

- Produktetiketten sitter bakom luckan till anslutningspanelen.
- Varning! För att förhindra eldsvåda får levande ljus eller andra föremål med öppen låga aldrig placeras eller användas i närheten av denna produkt.
- Produktetiketten er plassert bak dekelet på tilkoblingspanelet.
- Advarsel! Hold levende lys eller andre åpne flammekilder unna produktet til enhver tid for å unngå brann.
- Die Produktkennzeichnung befindet sich hinter der Abdeckung des Anschlussfelds.
- Achtung! Um das Entfachen und Ausbreiten eines Feuers zu verhindern, sollten Sie mit Kerzen oder anderen offenen Flammen stets einen großen Abstand zu diesem Gerät einhalten.
- Het productlabel bevindt zich achter het afdekplaatje van het aansluitpaneel.
- Waarschuwing! Om de verspreiding van vuur te voorkomen, moet u kaarsen en andere naakte vlammen altijd van dit product verwijderd houden.
- L'étiquette du produit se trouve derrière le cache du panneau de connexion.

- Avertissement ! Pour éviter tout risque d'incendie, toujours tenir le produit à l'écart des bougies et autres flammes nues.
- La etiqueta del equipo se encuentra situada tras la cubierta del panel de conexiones.
- ¡Advertencia! Con objeto de evitar la propagación de un posible incendio, mantenga las velas y demás fuentes de llamas expuestas alejadas del equipo en todo momento.
- L'etichetta del prodotto è ubicata dietro al coperchio del pannello delle prese.
- Attenzione! Per prevenire possibili incendi, non posizionare candele o altre fiamme libere nelle vicinanze del prodotto.
- Товарная этикетка находится под крышкой коммутационной панели.
- Внимание! Во избежание пожара никогда не размещайте свечи и другие источники открытого огня рядом с аппаратом.
- 产品标签位于连接面板护盖后方。
- 警告! 为避免火势蔓延, 在任何时候都应使蜡烛或其它明火远离本产品。

- 4 BeoRemote One
- 6 English
- 8 Dansk (Danish)
- 10 Svenska (Swedish)
- 12 Norsk (Norwegian)
- 14 Deutsch (German)
- 16 Nederlands (Dutch)
- 18 Français (French)
- 20 Español (Spanish)
- 22 Italiano (Italian)
- 24 Русский (Russian)
- 26 简体中文 (Simplified Chinese)

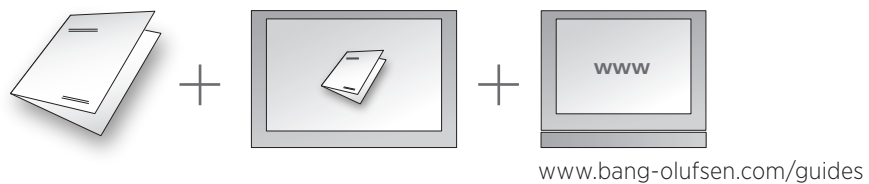

Technical specifications, features and the use thereof are subject to change without notice.

## BeoRemote One

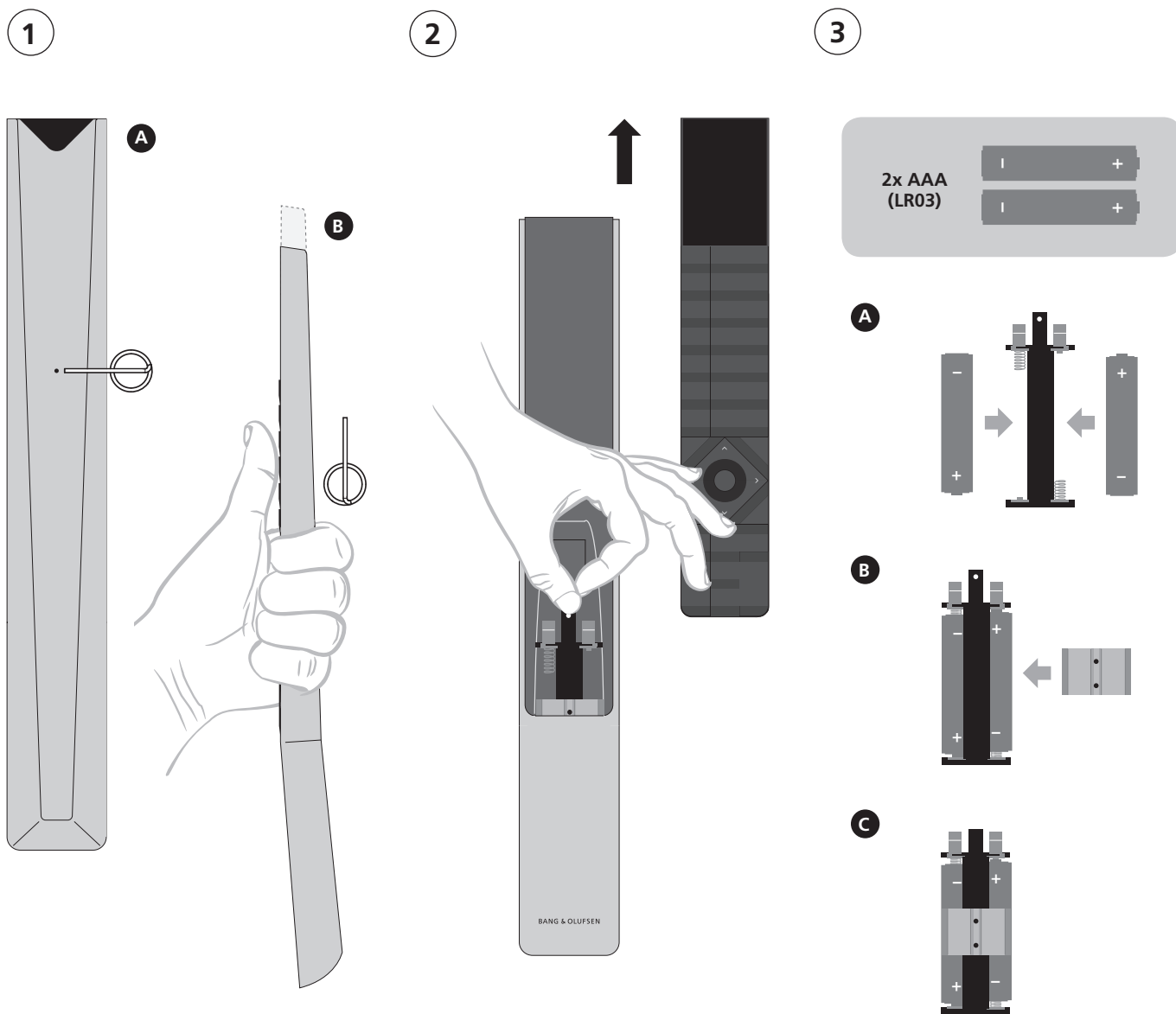

[www.bang-olufsen.com/guides/BeoRemoteOne](http://www.bang-olufsen.com/guides/BeoRemoteOne)

**English:** Connect the television to the mains before you insert batteries in the remote control.

**Dansk:** Slut TV'et til strømmen, inden du sætter batterier i fjernbetjeningen.

**Svenska:** Anslut TV:n till elnätet innan du sätter i batterierna i fjärrkontrollen.

**Norsk:** Koble TV-en til strømtaket før du setter batteriene i fjernkontrollen.

**Deutsch:** Verbinden Sie das TV-Gerät mit dem Stromnetz, bevor Sie die Batterien in die Fernbedienung einlegen.

**Nederlands:** Steek de stekker van de televisie in het stopcontact voordat u batterijen in de afstandsbediening plaatst.

4

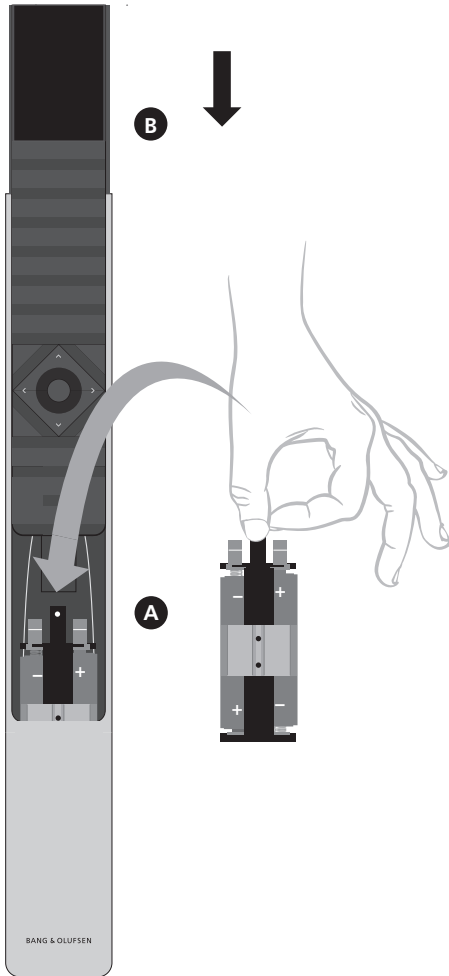

5

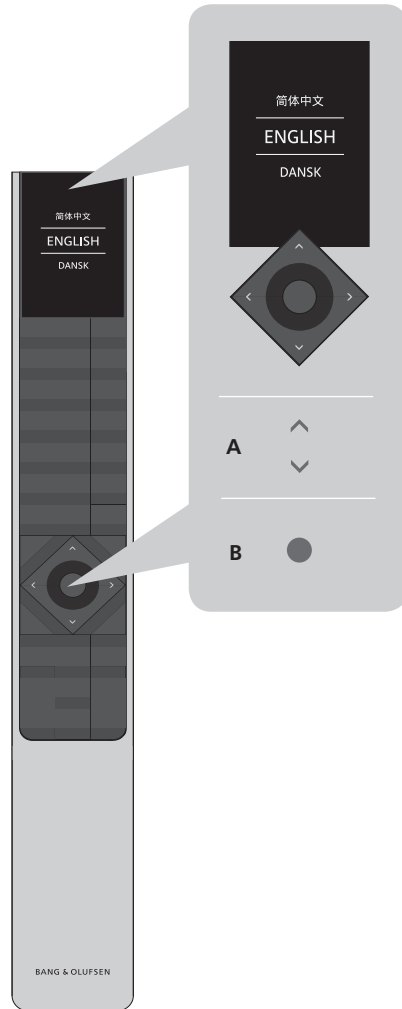

6

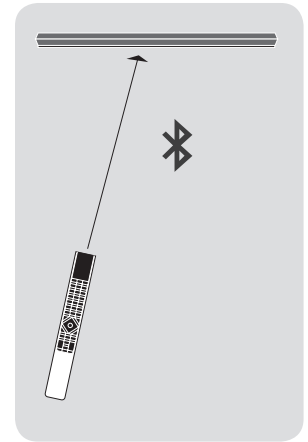

Français : Raccordez le téléviseur à l'alimentation secteur avant d'insérer les piles dans la télécommande.

Español: Conecte el televisor a la red eléctrica antes de insertar las pilas en el terminal a distancia.

Italiano: Prima di inserire le batterie nel telecomando, collegare il televisore alla rete elettrica.

Русский: Прежде чем вставить батарейки в пульт дистанционного управления, подключите телевизор к сети электропитания.



















简体中文: 在遥控器装入电池之前, 将电视机连接电源。

# How to use your remote control

## BeoRemote One operation

Your television can be operated with BeoRemote One as described here, in the product and in the online guide available on [www.bang-olufsen.com/guides](http://www.bang-olufsen.com/guides). The guide offers information about connections, setup, features and functions.



-  **TV** The display shows you a list of sources or functions when it is switched on
-  **TV** Switch on the television from standby and display available television sources in the display for you to switch on. Use  $\wedge$  or  $\vee$  to step in the list\*
-  **MUSIC** Display available music sources in the display for you to switch on. Use  $\wedge$  or  $\vee$  to step in the list\*
-  **MyButtons**. Long press to store the current setup, such as source, sound and picture settings. Short press to select it
-  **0-9** Select channels and enter information in on-screen menus
-  **LIST** Display extra functions in the display. Use  $\wedge$  or  $\vee$  to step in the list
-  **GUIDE** Bring up the television Programme Guide
-  Leave or move backwards through menus and the BeoRemote One lists
-  **INFO** Bring up help texts and information on a menu or function
-  Bring up the Home menu and reveal available apps
-  Arrow buttons left, right, up and down  $\leftarrow$ ,  $\rightarrow$ ,  $\wedge$  and  $\vee$ . Move in menus and in the BeoRemote One display
-  **Centre** button used for selecting and activating sources, functions and settings
-  Select colour specific functions
-  Start playback of a track, file or recording or start replay
-  Search backwards or forwards step by step
-  **P +/-** Step through channels or stations
-  Pause playback of a programme or recording
-  Adjust volume. To mute, press the middle of the button
-  Standby

**Important** – guides are found on [www.bang-olufsen.com/guides](http://www.bang-olufsen.com/guides)

\***BeoRemote One sources** Some sources in the display can be reconfigured during the setup process. See the guide in the television for more information.  
NOTE! For general information about remote control operation, see the guide for your remote control.

To operate your television with BeoRemote One, the two must be paired. To open the television for pairing, you must first connect it to the mains.\*\* See the online guide for BeoRemote One for information on how to pair it to the television. Also, see the guide in your television for more information about pairing.

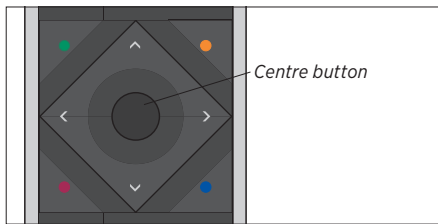

Use <, >, ^ and v to navigate in the television Home menu, in menus and in the BeoRemote One display. For example, you can use < and > to change picture format. Press the **centre** button to confirm selections in the Home menu and in menus and settings in menus.

To leave or back up through menus, press ←.

For more information, see the guide for your BeoRemote One remote control.

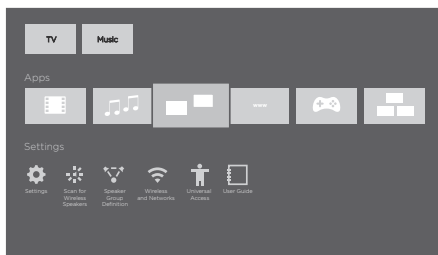

Example of a Home menu.

Use ⊞ to bring up the television Home menu. From here, you can access and download a variety of different apps. It is also here you find predefined apps for the television features, such as for the television settings menu. For more information, see the guide in your television.

You bring up the in-product guide by pressing the **blue** button when available in the menus.

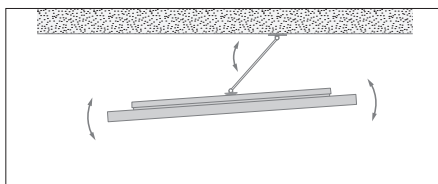

If your television is equipped with the optional wall bracket or floor stand, you can turn it manually. For more information about the wall bracket, see the guide for the wall bracket. For more information about the floor stand, see the guide for the floor stand.

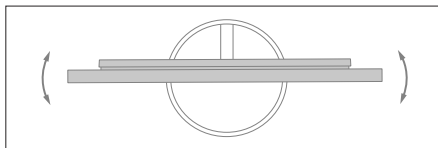

#### \*\*Bluetooth pairing of BeoRemote One

If the television is disconnected from the mains and then reconnected, it will enter Bluetooth pairing mode for you to pair with a BeoRemote One. Note that both the television and the remote control must be in pairing mode to be able to pair the two products. See the guide for BeoRemote One.

Warning: Prolonged listening at high volume levels (over 85dB) can cause hearing damage.

## Betjening med BeoRemote One

TV'et kan betjenes med BeoRemote One som beskrevet her, i vejledningen i produktet og i onlinevejledningen, som du kan finde på [www.bang-olufsen.com/guides](http://www.bang-olufsen.com/guides). Her finder du desuden oplysninger om tilslutningsmuligheder, opsætning, funktioner og meget mere.



- TV** Der vises en liste over kilder eller funktioner i displayet, når det tændes
- TV** Tænd for TV'et fra standbytilstanden, og se de TV-kilder, du kan tænde for, i displayet. Brug  $\wedge$  eller  $\vee$  til at gå trinvist op og ned i listen\*
- MUSIC** Se de musikklider, du kan tænde for, i displayet. Brug  $\wedge$  eller  $\vee$  til at gå trinvist op og ned i listen\*
- MitValg-knapper** Med et langt tryk gemmes den aktuelle opsætning, f.eks. kilde-, lyd- og billedindstillinger. Med et kort tryk vælges den
- 0-9** Vælg kanaler, og angiv oplysninger i skærmmenuer
- LIST** Se ekstrafunktioner i displayet. Brug  $\wedge$  eller  $\vee$  til at gå trinvist gennem listen
- GUIDE** Hent programoversigten frem
- ←** Forlad eller gå tilbage gennem menuerne og listerne i BeoRemote One
- INFO** Hent hjælpetekster og information om en menu eller funktion frem
- 🏠** Hent menuen Hjem frem, og se de tilgængelige apps
- ◀ ▶** Pileknapperne venstre, højre, op og ned  $\swarrow$ ,  $\searrow$  og  $\vee$ . Naviger i menuer og i displayet på BeoRemote One
- **Centerknappen** bruges til at vælge og aktivere kilder, funktioner og indstillinger
- ● ● ●** Vælg farvespecifikke funktioner
- ▶** Start afspilning af et musiknummer, en fil eller en optagelse, eller start genafspilning
- ⏮ ⏭** Søg trinvist frem eller tilbage
- P +/-** Gå trinvist gennem kanaler eller stationer
- ⏸** Sæt afspilning af et program eller en optagelse på pause
- 🔊 +/-** Juster lydstyrken. Tryk midt på knappen for at slå lyden fra
- ⏻** Standby

**Vigtigt!** – Du kan finde vejledningerne på [www.bang-olufsen.com/guides](http://www.bang-olufsen.com/guides)

\***BeoRemote One kilder** Nogle af de kilder, der vises i displayet, kan omkonfigureres under opsætningen. Se flere oplysninger i vejledningen i dit TV.  
BEMÆRK! Se generelle oplysninger om brug af fjernbetjeningen i vejledningen til fjernbetjeningen.



For at du kan bruge BeoRemote One sammen med TV'et, skal de to enheder først parres. TV'et skal være sluttet til strømmen, for at de to enheder kan parres.\*\* Se i onlinevejledningen til BeoRemote One, hvordan du parrer den med TV'et. Du kan også finde flere oplysninger om parring af disse to enheder i vejledningen i dit TV.

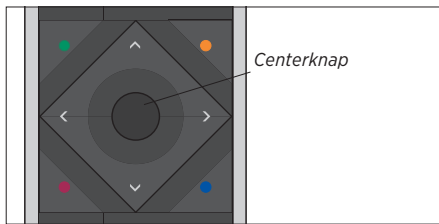

Tryk på <, >, ^ og v for at navigere i TV'ets menuer og på BeoRemote One displayet. For eksempel kan du skifte billedformat ved hjælp af < og >. Tryk på **centerknappen** for at bekræfte dine valg i menuen Hjem samt i menuer og i indstillinger i menuer.

For at gå tilbage gennem menuerne skal du trykke på ←.

Se vejledningen til din BeoRemote One fjernbetjening for yderligere oplysninger.

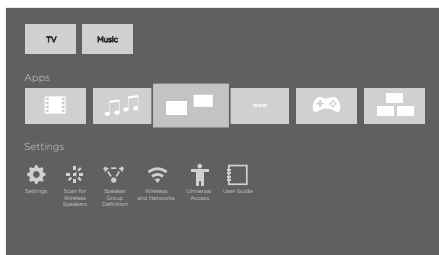

Eksempel på en Hjem-menu.

Brug  til at hente menuen Hjem frem på TV'et. Herfra har du adgang til en række forskellige apps, som du kan downloade. Her finder ud også prædefinerede apps til TV'ets forskellige funktioner, f.eks. til menuen Indstillinger. Se flere oplysninger i vejledningen i dit TV.

Den kan hente den guide, der er i TV'et, frem ved at trykke på den **blå** knap, når den er tilgængelig i menuerne.

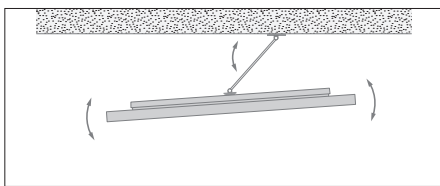

Hvis TV'et er udstyret med et vægbeslag eller en gulvstand, kan du dreje det manuelt. Du kan få flere oplysninger om vægbeslaget i vejledningen til vægbeslaget. Du kan få flere oplysninger om gulvstanden i vejledningen til gulvstanden.

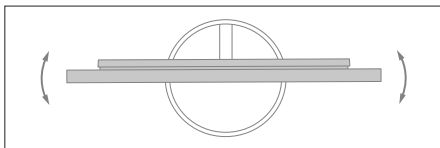

#### \*\*Bluetooth-parring af BeoRemote One

Hvis TV'et kobles fra strømmen og derefter tilkobles igen, går det automatisk i en tilstand, hvor du kan parre det med en BeoRemote One. Bemærk, at både TV og fjernbetjening skal være i denne tilstand, for at du kan parre de to produkter. Se vejledningen til BeoRemote One.



















Advarsel! Hvis du lytter til høj musik i længere tid (over 85 db), kan det medføre høreskader!

## Så använder du din fjärrkontroll

### BeoRemote One – handhavande

Du kan styra TV:n med BeoRemote One enligt beskrivningen här, på produkten och i onlinehandledningen på [www.bang-olufsen.com/guides](http://www.bang-olufsen.com/guides). Handledningen innehåller information om anslutningar, konfigurationer, inställningar och funktioner.



	<b>TV</b> Displayen visar en lista över källor eller funktioner när den är påslagen
	<b>TV</b> Aktivera TV:n från standbyläge och visa tillgängliga TV-källor på displayen som du kan växla till. Använd $\wedge$ eller $\vee$ för att bläddra i listan*
	<b>MUSIC</b> Visa tillgängliga musikkällor på displayen som du kan växla till. Använd $\wedge$ eller $\vee$ för att bläddra i listan*
	<b>MinaKnappar.</b> Håll in knappen för att spara den aktuella inställningen, t.ex. inställningar för källa, ljud eller bild. En kort tryckning väljer alternativet
	<b>0–9</b> Välj kanaler eller ange information på skärmmenyer
	<b>LIST</b> Visa ytterligare funktioner på displayen. Använd $\wedge$ eller $\vee$ för att bläddra i listan
	<b>GUIDE</b> Ta fram TV:ns programguide
	<b>←</b> Avsluta eller stega bakåt genom menyer och BeoRemote One-listorna
	<b>INFO</b> Ta fram hjälptexter och information om en meny eller funktion
	<b>☰</b> Ta fram hemmenyn och visa tillgängliga appar
	<b>&lt; &gt;</b> Pilknapparna vänster, höger, upp och ner $\wedge$ , $\vee$ och $\wedge$ och $\vee$ . Navigera i menyerna och BeoRemote One-skärmen
	<b>Mittknappen</b> används för att välja och aktivera källor, funktioner och inställningar
	Välj färgspecifika funktioner
	<b>▶</b> Starta uppspelningen av en låt, en fil eller inspelning eller en repris
	<b>⏮ ⏭</b> Stega bakåt eller framåt, steg för steg
	<b>P +/-</b> Stega genom kanaler eller stationer
	<b>⏸</b> Pausa uppspelning av ett program eller en inspelning
	<b>🔊 +/-</b> Justera volymen. För att stänga av ljudet, tryck mitt på knappen
	<b>⏻</b> Standby

**Viktigt** – handledningarna hittar du på [www.bang-olufsen.com/guides](http://www.bang-olufsen.com/guides)

\***BeoRemote One-källor** Vissa källor på displayen går att omkonfigurera vid installationen. Mer information finns i handledningen på TV:n.  
OBS! Allmän information om hur du använder fjärrkontrollen finns i handledningen till fjärrkontrollen.

För att kunna styra TV:n med din BeoRemote One måste du parkoppla enheterna. För att aktivera TV:n för parkoppling måste du först ansluta den till elnätet.\*\* Information om hur du parkopplar fjärrkontrollen med TV:n finns i onlinehandledningen för BeoRemote One. Du kan även hitta mer information om parkoppling i handledningen som finns i TV:n.



Använd <, >, ^ och v för att navigera i TV:ns hemmeny, i menyer och på BeoRemote One-displayen. Du kan till exempel använda < och > för att ändra bildformat. Tryck på **mittknappen** för att bekräfta valda alternativ i startmenyn och menyer och inställningar i menyerna. Gå tillbaka genom menyerna eller avsluta menyer genom att trycka på ←. Mer information finns i handledningen för BeoRemote One-fjärrkontrollen.

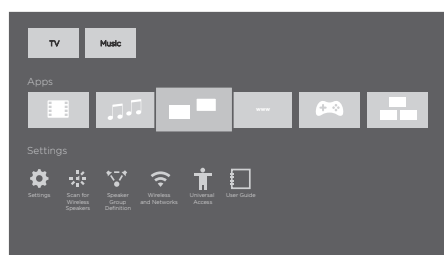

Exempel på en hemmeny.

Tryck på ☰ för att visa hemmenyn på TV:n. Härifrån kan du öppna och hämta många olika typer av appar. Du kan även hitta fördefinierade appar för TV:ns funktioner, till exempel appar för inställningsmenyn på TV:n. Mer information finns i handledningen på TV:n.

Om du vill ta fram den inbyggda handledningen trycker du på den **blå** knappen när den visas i menyerna.

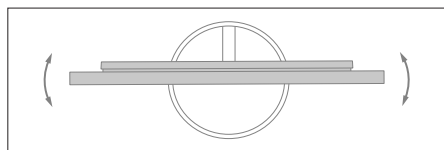
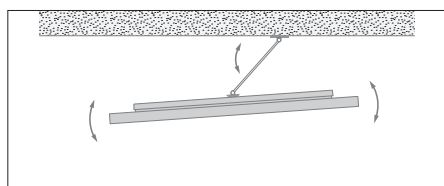

Om TV:n har ett väggfäste eller golvstativ som tillval kan du vrida den manuellt. För mer information om väggfästet, se handledningen för väggfästet. För mer information om golvstativet, se handledningen för golvstativet.

### \*\*Parkoppling av BeoRemote One via Bluetooth

Om TV:n är bortkopplad från elnätet och sedan ansluts på nytt övergår den till läget för Bluetooth-parkoppling, så att du kan parkoppla TV:n med en BeoRemote One. Observera att både TV:n och fjärrkontrollen måste vara i parkopplingsläge för att de två produkterna ska kunna parkopplas. Mer information finns i handledningen till BeoRemote One.

Varning! Långvarig lyssning på hög volym (över 85 dB) kan orsaka hörselskador.

## Slik bruker du fjernkontrollen

### Bruk av BeoRemote One

TV-en kan betjenes med BeoRemote One slik det er beskrevet her, i informasjonen som følger med produktet, samt i veiledningen på nett som er tilgjengelig på [www.bang-olufsen.com/guides](http://www.bang-olufsen.com/guides). Veiledningen inneholder informasjon om tilkoblinger, oppsett og funksjoner.



- TV** I skjermen vises en liste over funksjoner når fjernkontrollen er slått på
- TV** Slår på TV-en fra standby og viser TV-kildene du kan velge mellom i displayet. Bruk  $\wedge$  eller  $\vee$  til å bla i listen\*
- MUSIC** Viser musikkildene du kan velge mellom i displayet. Bruk  $\wedge$  eller  $\vee$  til å bla i listen\*
- MyButtons.** Trykk og hold inne for å lagre gjeldende innstillinger, som for eksempel kilde, lyd og bilde. Trykk raskt én gang for å velge
- 0-9** Velger kanaler og angir informasjon i menyene på skjermen
- LIST** Viser ekstra funksjoner i displayet. Bruk  $\wedge$  eller  $\vee$  til å bla i listen
- GUIDE** Åpner programguiden på TV-en.
- ←** Gå ut av eller tilbake i menyene og BeoRemote One-listene
- INFO** Viser hjelpetekster og informasjon om en meny eller funksjon
- 🏠** Åpner Hjem-menyen og viser tilgjengelige apper
- < >** Pilknapper venstre, høyre, opp og ned  $\swarrow$ ,  $\searrow$  og  $\downarrow$ . Navigerer i menyer og i BeoRemote One-skjermen
- **Knappen i midten** brukes til å velge og aktivere kilder, funksjoner og innstillinger
- ● ● ●** Velger fargespesifikke funksjoner
- ▶** Starter avspilling av spor, fil eller opptak, eller starter ny avspilling
- ⏮ ⏭** Søker trinnvis bakover eller forover
- P +/-** Blar gjennom kanaler eller stasjoner
- ⏸** Stanser opptak eller avspilling av et program midlertidig
- 🔊 +/-** Justerer volumet Trykk midt på knappen for å slå av lyden
- ⏻** Standby

**Viktig** – veiledningene finner du på [www.bang-olufsen.com/guides](http://www.bang-olufsen.com/guides)

\***BeoRemote One-kilder** Enkelte kilder som vises på skjermen, kan konfigureres på nytt under oppsettet. Du finner mer informasjon i veiledningen for TV-en. MERK! Du finner generell informasjon om betjening av fjernkontrollen, i veiledningen for fjernkontrollen.

BeoRemote One må være koblet til TV-en for å kunne betjene den. TV-en må først kobles til strømuttak for å kunne kobles til fjernkontrollen.\*\* Du finner informasjon om tilkoblingen i veiledningen for BeoRemote One på nettet. Du finner også mer informasjon om tilkoblingen i veiledningen for TV-en.

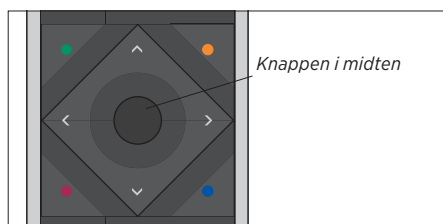

Bruk <, >, ^ og v for å navigere i TV-ens Hjem-meny, i menyene og i displayet på BeoRemote One. Du kan for eksempel bruke < og > til å endre bildeformat. Trykk på knappen i midten for å bekrefte valg i Hjem-menyen og i menyene og innstillingene for menyene. Hvis du vil gå ut av eller tilbake i en meny, trykker du på ←. Du finner mer informasjon i veiledningen for fjernkontrollen BeoRemote One.



Eksempel på en Hjem-meny

Bruk ⏪ for å åpne Hjem-menyen på TV-en. Her får du tilgang til og kan laste ned en rekke forskjellige apper. Her finner du også forhåndsdefinerte apper for TV-ens funksjoner, som for eksempel for innstillingsmenyen for TV-en. Du finner mer informasjon i veiledningen for TV-en.

Åpne produktets veiledning ved å trykke på den blå knappen når den er tilgjengelig i menyer.

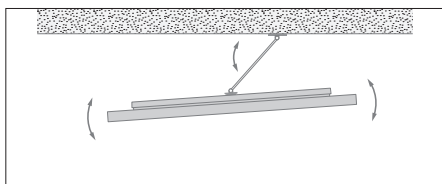

Hvis TV-en er utstyrt med motorisert gulvsokkel (ekstraustyr) eller veggbrakett, kan du slå den på med fjernkontrollen. Du finner mer informasjon om veggbraketten i veiledningen som følger med den. Du finner mer informasjon om gulvsokkelen i veiledningen som følger med den.

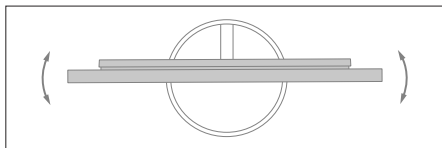

#### \*\*Bluetooth-tilkobling av BeoRemote One

Hvis TV-en kobles fra strømkontakten og deretter kobles til på nytt, åpnes Bluetooth-tilkoblingsmodusen der du kan koble til BeoRemote One. Vær oppmerksom på at både TV-en og fjernkontrollen må være i tilkoblingsmodus for at de to produktene skal kunne kobles sammen. Se veiledningen for BeoRemote One.

Advarsel: Langvarig lytting ved høye volumnivåer (over 85 dB) kan forårsake hørselsskader.

## BeoRemote One – Bedienung

Bedienen Sie Ihr TV-Gerät mit der BeoRemote One. Informationen zur Bedienung finden Sie hier, in der Produkthanleitung oder in der Online-Bedienungsanleitung, die unter [www.bang-olufsen.com/guides](http://www.bang-olufsen.com/guides) verfügbar ist. In der Anleitung finden Sie Hinweise zu Anschlüssen, Konfiguration, Eigenschaften und Funktionen.



The diagram shows the BeoRemote One remote control with callouts to various buttons and their functions. The remote has a display at the top showing 'TV' and 'HOMEMEDIA'. Below the display are buttons for 'TV', 'MUSIC', '0-9', 'LIST', 'GUIDE', 'INFO', and a directional pad. Below the directional pad are buttons for 'P+', 'P-', and a central button. At the bottom are buttons for 'P +/-' and a red standby button.

- TV** Auf dem Display wird eine Liste der Quellen oder Funktionen angezeigt, wenn es eingeschaltet ist.
- TV** TV-Gerät im Standby-Betrieb einschalten und verfügbare TV-Quellen auf dem Display anzeigen. Mit  $\wedge$  oder  $\vee$  können Sie durch die Liste blättern.\*
- MUSIC** Verfügbare Musikquellen auf dem Display anzeigen. Mit  $\wedge$  oder  $\vee$  können Sie durch die Liste blättern.\*
- MyButtons** Lange gedrückt halten, um die aktuellen Einstellungen (Quellen-, Audio- und Bildeinstellungen) zu speichern. Zur Auswahl kurz drücken
- 0–9** Kanäle auswählen und Daten in Bildschirmenüs eingeben
- LIST** Weitere Funktionen auf dem Display anzeigen. Mit  $\wedge$  oder  $\vee$  können Sie durch die Liste blättern.
- GUIDE** Programmführer aufrufen
- ←** Menüs und die BeoRemote One Liste verlassen oder durch die Menüs und die Liste zurückgehen
- INFO** Hilfetexte und Informationen zu einem Menü oder einer Funktion aufrufen
- Home** Home-Menü aufrufen und verfügbare Apps anzeigen
- ← >** Pfeiltasten nach links, rechts, oben und unten ( $\langle$ ,  $\rangle$ ,  $\wedge$  und  $\vee$ ). In den Menüs und auf dem BeoRemote One Display navigieren
- Mittlere Taste** zum Auswählen und Aktivieren von Quellen, Funktionen und Einstellungen
- Farbspezifische Funktionen** auswählen
- ▶** Titel, Datei oder Aufnahme oder Wiedergabe starten
- ⏮ ⏭** Schritt für Schritt im Rück-/Vorlauf suchen
- P +/-** Zwischen Kanälen oder Sendern umschalten
- ||** Wiedergabe eines Programms oder einer Aufnahme unterbrechen
- 🔊 +/-** Lautstärke einstellen. Zum Stummschalten auf die Tastenmitte drücken
- Standby**

**Wichtig:** Anleitungen finden Sie unter [www.bang-olufsen.com/guides](http://www.bang-olufsen.com/guides)

\* **BeoRemote One Quellen** Manche Quellen auf dem Display können bei der Ersteinstellung umprogrammiert werden. Nähere Informationen finden Sie in der Bedienungsanleitung Ihres TV-Geräts.  
HINWEIS: Allgemeine Informationen zur Benutzung Ihrer Fernbedienung entnehmen Sie der Bedienungsanleitung der Fernbedienung.

Um Ihr TV-Gerät mit der BeoRemote One bedienen zu können, müssen beide Geräte gekoppelt sein. Um das TV-Gerät für die Kopplung zu aktivieren, müssen Sie es erst an das Stromnetz anschließen.\*\* Nähere Informationen zur Kopplung von BeoRemote One und dem TV-Gerät finden Sie in der Online-Bedienungsanleitung. Weitere Informationen zur Kopplung finden Sie auch in der Bedienungsanleitung für Ihr TV-Gerät.

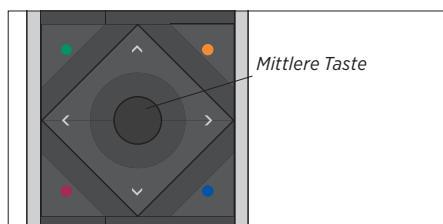

Verwenden Sie  $\leftarrow$ ,  $\rightarrow$ ,  $\uparrow$  und  $\downarrow$ , um im Home-Menü und den Menüs des TV-Geräts sowie auf dem BeoRemote One Display zu navigieren. Mit  $\leftarrow$  und  $\rightarrow$  können Sie beispielsweise das Bildformat ändern. Drücken Sie die **mittlere** Taste, um Ihre Auswahl im Startmenü und in den Menüs bzw. die Einstellungen in den Menüs zu bestätigen.

Um ein Menü zu verlassen oder um zurückzugehen, drücken Sie  $\leftarrow$ .

Weitere Informationen finden Sie in der Bedienungsanleitung für Ihre BeoRemote One Fernbedienung.

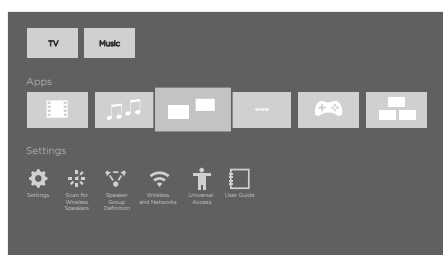

Beispiel eines Home-Menüs

Verwenden Sie  $\leftarrow$ , um das Home-Menü des TV-Geräts aufzurufen. Von hier aus können Sie auf eine Vielzahl von Apps zugreifen und diese herunterladen. Hier finden Sie auch vordefinierte Apps für die TV-Eigenschaften, wie z. B. das Einstellungen-Menü des TV-Geräts. Weitere Informationen finden Sie in der Bedienungsanleitung Ihres TV-Geräts.

Falls diese in den Menüs verfügbar ist, können Sie die Produktanleitung aufrufen, indem Sie die **blaue** Taste drücken.

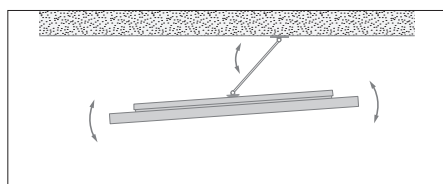

Wenn Ihr TV-Gerät mit der optionalen Wandhalterung oder dem optionalen Bodenstandfuß mit Motordrehfunktion ausgestattet ist, können Sie das Gerät mit der Fernbedienung drehen. Weitere Informationen zur Wandhalterung finden Sie in der Anleitung der Wandhalterung. Weitere Informationen zum Bodenstandfuß finden Sie in der Anleitung des Bodenstandfußes.

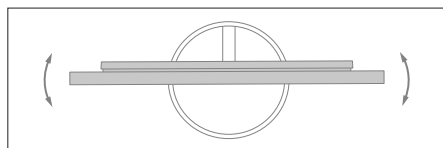

#### \*\* Bluetooth-Verbindung der BeoRemote One

Falls das TV-Gerät vom Stromnetz getrennt und anschließend wieder verbunden wird, wird automatisch der Bluetooth-Verbindungsmodus aktiviert, damit Sie eine BeoRemote One verbinden können. Beachten Sie, dass sich sowohl das TV-Gerät als auch die Fernbedienung im Verbindungsmodus befinden müssen, damit die beiden Produkte verbunden werden können. Nähere Informationen finden Sie in der Bedienungsanleitung der BeoRemote One.

Achtung: Eine längere Benutzung bei hoher Lautstärke (über 85 dB) kann Gehörschäden verursachen!

## De afstandsbediening gebruiken

### BeoRemote One-bediening

Uw televisie kan worden bediend met de BeoRemote One zoals hier beschreven, in het product en in de online handleiding, beschikbaar op [www.bang-olufsen.com/guides](http://www.bang-olufsen.com/guides). In de handleiding vindt u informatie over aansluitingen, instellingen, kenmerken en functies.



The diagram shows the BeoRemote One remote control with various buttons highlighted and labeled with their functions. The remote has a display at the top showing 'TV' and 'HOMEMEDIA'. Below the display are buttons for 'TV', 'MUSIC', '0-9', 'LIST', 'GUIDE', 'INFO', and a directional pad. At the bottom are buttons for 'P+', 'P-', 'P +/-', 'II', and a speaker icon with '+/-'.

- TV** De display geeft, indien ingeschakeld, een lijst van bronnen of functies weer
- TV** Schakelt de televisie in vanuit standby en geeft beschikbare televisiebronnen weer in de display zodat u die kunt aanzetten. Gebruik  $\wedge$  of  $\vee$  om door de lijst te bladeren\*
- MUSIC** Geeft beschikbare muziekbronnen weer in de display zodat u die kunt aanzetten. Gebruik  $\wedge$  of  $\vee$  om door de lijst te bladeren\*
- MyButtons** Lang indrukken om de huidige opstelling, zoals bron, geluids- en beeldinstellingen op te slaan. Kort indrukken om een opgeslagen opstelling op te roepen
- 0-9** Selecteert kanalen en voert gegevens in schermmenu's in
- LIST** Geeft extra functies weer in de display. Gebruik  $\wedge$  of  $\vee$  om door de lijst te bladeren
- GUIDE** Opent de programmagids van de televisie
- ←** Stuit menu's en bladert terug door menu's en de BeoRemote One-lijsten.
- INFO** Roept helpteksten en informatie over een menu of functie op
- Home** Roept het menu Home op en geeft de beschikbare apps weer
- ← ◇ →** Pijltjestoetsen links, rechts, omhoog en omlaag  $\leftarrow$ ,  $\rightarrow$ ,  $\wedge$  en  $\vee$ . Navigeren in menu's en in de BeoRemote One-display
- Middelste toets**, gebruikt om bronnen, functies en instellingen te selecteren en activeren
- Color buttons** Selecteert kleurspecifieke functies
- ▶** Start het afspelen van een track, bestand of opname of start de herhaling
- ⏮ ⏭** Zoekt stap voor stap achterwaarts of voorwaarts
- P +/-** Wisselt tussen kanalen of zenders
- II** Pauzeert het afspelen van een programma of opname
- 🔊 +/-** Past het volume aan. Druk op het midden van de toets om het geluid uit te schakelen
- Standby**

**Belangrijk** – bedieningshandleidingen vindt u op [www.bang-olufsen.com/guides](http://www.bang-olufsen.com/guides)

**\*BeoRemote One-bronnen** Sommige bronnen op de display kunnen tijdens het set-upproces opnieuw worden geconfigureerd. Raadpleeg voor meer informatie de bedieningshandleiding in de televisie. OPMERKING! Algemene informatie over de bediening met afstandsbediening vindt u in de bedieningshandleiding van uw afstandsbediening.



Om uw televisie te bedienen met de BeoRemote One moeten beide toestellen gekoppeld zijn. Om de televisie te kunnen koppelen, moet u eerst de stekker in het stopcontact steken.\*\* Raadpleeg de online bedieningshandleiding van de BeoRemote One voor informatie over het koppelen van een televisie. Raadpleeg ook de bedieningshandleiding in uw televisie voor meer informatie over koppelen.

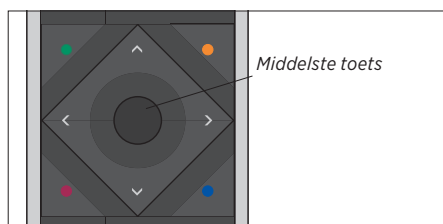

Gebruik  $\leftarrow$ ,  $\rightarrow$ ,  $\wedge$  en  $\vee$  om in het menu Home van de tv, in de andere menu's en in de BeoRemote One-display te navigeren. Zo kunt u bijvoorbeeld  $\leftarrow$  en  $\rightarrow$  gebruiken om het beeldformaat te wijzigen. Druk op de **middelste** toets om keuzes in het menu Home en in andere menu's en instellingen in menu's te bevestigen. Druk op  $\leftarrow$  om af te sluiten of terug te keren naar vorige menu's.

Raadpleeg de handleiding van uw BeoRemote One-afstandsbediening voor meer informatie.



Voorbeeld van een menu Home.

Gebruik  $\square$  om het menu Home van de televisie te openen. Vervolgens kunt u een heleboel verschillende apps zoeken en downloaden. Hier vindt u ook voorgedefinieerde apps voor de televisiefuncties, zoals voor het menu instellingen van de televisie. Raadpleeg voor meer informatie de bedieningshandleiding in uw televisie.

U kunt de handleiding openen in het product zelf door op de **blauwe** toets te drukken indien beschikbaar in de menu's.

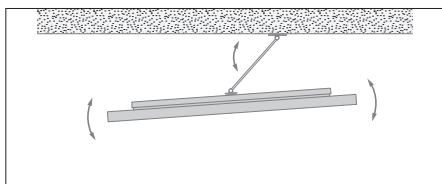

Als uw televisietoestel is uitgerust met de optionele gemotoriseerde muurbeugel of vloerstand, dan kunt u deze handmatig draaien. Raadpleeg voor meer informatie over de muurbeugel de handleiding voor de muurbeugel. Raadpleeg voor meer informatie over de vloerstand de handleiding voor de vloerstand.

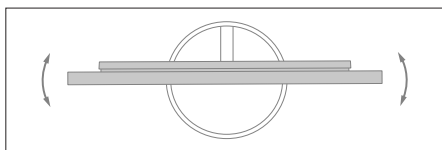

#### \*\*Bluetooth-koppeling met BeoRemote One



















Als de stekker van de televisie wordt uitgetrokken en weer wordt ingestoken, zal de Bluetooth-modus voor koppeling worden gestart zodat u een BeoRemote One kunt koppelen. Denk eraan dat zowel de televisie als de afstandsbediening in de koppelmodus moeten staan om de twee toestellen te kunnen koppelen. Raadpleeg de handleiding van de BeoRemote One.

Waarschuwing: Langdurige blootstelling aan hard geluid kan uw gehoor beschadigen!



## Fonctionnement de la BeoRemote One

Vous pouvez utiliser votre téléviseur à l'aide de la BeoRemote One, comme expliqué dans ce guide produit ainsi que dans le manuel en ligne disponible à l'adresse [www.bang-olufsen.com/guides](http://www.bang-olufsen.com/guides). Le manuel contient des informations sur la connectivité, la configuration, les caractéristiques et les fonctionnalités.

-  **TV** L'écran affiche une liste des sources ou fonctions lorsqu'il est allumé
-  **TV** Permet d'allumer le téléviseur à partir du mode veille et d'afficher les sources télévisées disponibles à l'écran pour pouvoir les activer. Appuyez sur  $\wedge$  ou  $\vee$  pour parcourir la liste\*
-  **MUSIC** Permet d'afficher les sources musicales disponibles à l'écran pour pouvoir les activer. Appuyez sur  $\wedge$  ou  $\vee$  pour parcourir la liste\*
-  **MyButtons.** Appuyez de manière prolongée pour mémoriser la configuration actuelle, telle que le réglage de la source, du son et de l'image. Appuyez brièvement pour la sélectionner
-  **0-9** Permet de sélectionner des chaînes et d'entrer des informations dans les menus à l'écran
-  **LIST** Permet d'afficher des fonctions supplémentaires à l'écran. Appuyez sur  $\wedge$  ou  $\vee$  pour parcourir la liste
-  **GUIDE** Permet d'afficher le programme TV
-  Permet de quitter ou de revenir en arrière dans les menus et les listes de la BeoRemote One
-  **INFO** Permet d'afficher les textes d'aide et les informations sur un menu ou une fonction
-  Permet d'afficher le menu d'accueil et d'accéder aux applications disponibles
-  **< >** Boutons fléchés vers la gauche  $\leftarrow$ , la droite  $\rightarrow$ , le haut  $\wedge$  et le bas  $\vee$ . Permet de parcourir les menus et l'écran de la BeoRemote One
-  **Bouton central** utilisé pour la sélection et l'activation des sources, fonctions et réglages
-  Permet de sélectionner des fonctions spécifiques à une couleur
-  Permet de lancer la lecture d'une piste, d'un fichier ou d'un enregistrement ou de reprendre la lecture
-  Permet de rechercher en arrière ou en avant, étape par étape
-  Permet de parcourir les chaînes ou stations
-  Permet de mettre la lecture ou l'enregistrement d'un programme sur pause
-  Permet de régler le volume. Pour couper le son, appuyez au milieu de la touche
-  **Veille**

**Important** : les manuels sont disponibles à l'adresse [www.bang-olufsen.com/guides](http://www.bang-olufsen.com/guides).

**\*Sources de la BeoRemote One** Certaines sources affichées à l'écran peuvent être reconfigurées lors de la procédure d'installation. Pour plus d'informations, reportez-vous au manuel de votre téléviseur.  
**REMARQUE !** Pour des informations générales sur le fonctionnement de votre télécommande, reportez-vous au manuel correspondant.

Pour utiliser votre téléviseur à l'aide de la BeoRemote One, celle-ci doit être associée au téléviseur. Pour permettre l'association avec votre téléviseur, vous devez d'abord le raccorder à l'alimentation secteur.\*\* Consultez le manuel en ligne de la BeoRemote One pour savoir comment l'associer au téléviseur. Vous trouverez également des informations plus détaillées sur l'association dans le guide de votre téléviseur.

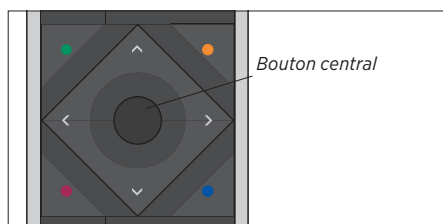

Appuyez sur <, >, ^ et v pour parcourir les différents menus, y compris le menu d'accueil du téléviseur, et l'écran de la BeoRemote One. Vous pouvez, par exemple, utiliser les touches < et > pour modifier le format d'image. Appuyez sur le bouton **central** pour confirmer les sélections dans les différents menus, y compris le menu d'accueil, et les réglages. Pour revenir aux menus précédents ou quitter, appuyez sur ←. Pour plus d'informations, reportez-vous au manuel de votre télécommande BeoRemote One.



Exemple de menu d'accueil.

Utilisez ☰ pour afficher le menu d'accueil du téléviseur. À partir d'ici, vous pouvez accéder à toute une série d'applications et les télécharger. Ce menu propose également des applications prédéfinies pour les fonctionnalités du téléviseur, telles que le menu de réglages du téléviseur. Pour plus d'informations, reportez-vous au manuel de votre téléviseur.

Pour afficher le manuel du produit, appuyez sur la touche **bleue** lorsqu'elle est disponible dans les menus.

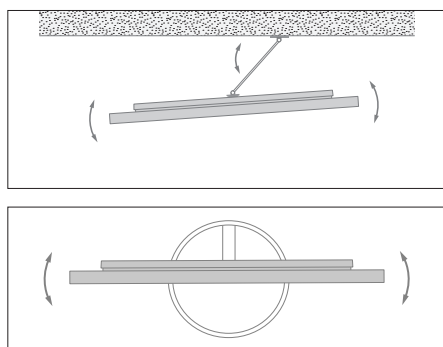

Si votre téléviseur est équipé du support mural ou du pied en option, vous pouvez le tourner manuellement. Pour plus d'informations sur le support mural, reportez-vous au manuel du support. Pour plus d'informations sur le pied, reportez-vous au manuel du pied.

#### \*\*Association Bluetooth de la BeoRemote One

Si le téléviseur est déconnecté du secteur, puis reconnecté, il passera au mode d'association Bluetooth pour vous permettre de l'associer à une télécommande BeoRemote One. Notez que le téléviseur et la télécommande doivent être tous les deux en mode d'association pour pouvoir les associer. Reportez-vous au manuel de la BeoRemote One.

Avertissement : Une écoute prolongée à fort volume (plus de 85 dB) peut entraîner des pertes d'audition.

## Uso de BeoRemote One

El televisor se puede controlar con BeoRemote One según lo descrito aquí, en el equipo y en la guía en línea disponible en [www.bang-olufsen.com/guides](http://www.bang-olufsen.com/guides). La guía ofrece información acerca de las conexiones, la configuración, las características y las funciones.



The diagram shows the BeoRemote One remote control with callouts to various buttons and their functions. The remote has a screen at the top displaying 'TV' and 'HOMEMEDIA'. Below the screen are buttons for 'TV', 'MUSIC', '0-9', 'LIST', 'GUIDE', 'INFO', and a home button. The central part of the remote features a directional pad and a central button. At the bottom, there are buttons for 'P+', 'P-', 'P +/-', a volume button, and a standby button.

- TV** La pantalla muestra una lista de fuentes o funciones mientras se encuentra activa.
- TV** Encender el televisor desde el modo standby y mostrar las fuentes de televisión disponibles en la pantalla para encenderlas. Pulse  $\wedge$  o  $\vee$  para recorrer la lista.\*
- MUSIC** Mostrar las fuentes de música disponibles en la pantalla para activar cualquiera de ellas. Pulse  $\wedge$  o  $\vee$  para recorrer la lista.\*
- MisBotones** Mantenga pulsado cualquiera de estos botones para guardar la configuración actual de fuente, sonido e imagen. Pulse uno de ellos brevemente para seleccionar la configuración almacenada.
- 0-9** Seleccionar canales o introducir información en los menús en pantalla.
- LIST** Mostrar las funciones complementarias en la pantalla. Pulse  $\wedge$  o  $\vee$  para recorrer la lista.
- GUIDE** Abrir la guía de programación del televisor.
- ←** Abandonar o retroceder a través de los menús y las listas de BeoRemote One.
- INFO** Abrir los textos de ayuda e información al acceder a un menú o una función.
- Home** Abrir el menú principal y ver las apps disponibles.
- ← ▷ ↖ ↘** Botones de dirección hacia la izquierda, hacia la derecha, hacia arriba y hacia abajo ( $\leftarrow$ ,  $\rightarrow$ ,  $\wedge$  y  $\vee$ ). Permiten desplazarse por los menús y la pantalla de BeoRemote One.
- Botón **central**. Permite seleccionar y activar fuentes, funciones y parámetros.
- ● ● ●** Seleccionar la función asignada al color correspondiente.
- ▶** Iniciar la reproducción de una pista, un archivo o una grabación, o iniciar una repetición.
- ⏮ ⏭** Retroceder o avanzar paso a paso.
- P +/-** Recorrer los canales o emisoras.
- ⏸** Pausar la reproducción de un programa o una grabación.
- 🔊 +/-** Ajustar el nivel de volumen. Pulse la parte central de este botón para desactivar el sonido.
- ⏻** Pasar el equipo al modo standby.

**Importante** – visite el sitio web [www.bang-olufsen.com/guides](http://www.bang-olufsen.com/guides) para descargar las guías disponibles

\* **Fuentes de BeoRemote One** Algunas de las fuentes que aparecen en la pantalla se pueden reconfigurar durante el proceso de configuración. Consulte la guía integrada en el televisor para más información.  
¡NOTA! Si desea obtener información de carácter general acerca del control con un terminal a distancia, consulte la guía del terminal a distancia.

Para controlar el televisor con BeoRemote One, es preciso emparejar el equipo y el terminal a distancia. Conecte el televisor a la red eléctrica para habilitar el modo de emparejamiento.\*\* Si desea obtener información acerca de cómo emparejar BeoRemote One con el televisor, consulte la guía en línea del terminal a distancia. Consulte también la guía integrada en el televisor para más información acerca del emparejamiento.

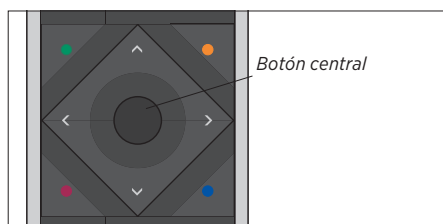

Use los botones <, >, ^ y v para navegar por el menú principal del televisor, los demás menús y la pantalla de BeoRemote One. Por ejemplo, puede pulsar < y > para cambiar el formato de la imagen. Pulse el botón **central** para confirmar una selección en el menú principal o en los demás menús, o una configuración en un menú. Para retroceder por los menús, pulse ←. Si desea obtener más información, consulte la guía del terminal a distancia BeoRemote One.



Ejemplo de un menú principal.

Pulse  para abrir el menú principal del televisor. Dicho menú permite acceder a diferentes apps, así como descargarlas. En él encontrará también las apps predefinidas que facilitan el control de las funciones del televisor, así como la que permite acceder al menú de configuración. Si desea obtener más información, consulte la guía integrada en el televisor.

Para abrir la guía integrada en el equipo, pulse el botón **azul** cuando esté disponible en los menús.

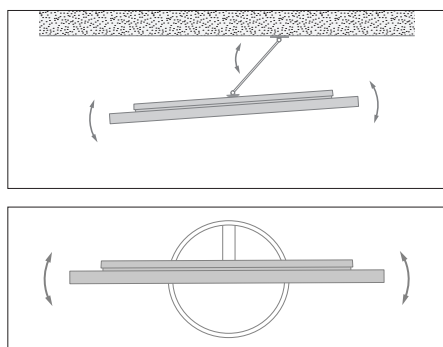

Si el televisor está equipado con el soporte de suelo o pared opcional, podrá girarlo manualmente. Si desea obtener más información acerca del soporte de pared, consulte la guía que lo acompaña. Si desea obtener más información acerca del soporte de suelo, consulte la guía que lo acompaña.

#### \*\* Emparejamiento Bluetooth de BeoRemote One

Si el televisor se desconecta de la red eléctrica y se conecta a continuación, se activará el modo de emparejamiento Bluetooth, que permite emparejar un terminal a distancia BeoRemote One. Recuerde que tanto el televisor como el terminal a distancia deben encontrarse en el modo de emparejamiento para que este tenga lugar correctamente entre ambos. Consulte la guía de BeoRemote One.

Advertencia: La escucha prolongada de sonidos a un elevado nivel de volumen (más de 85 dB) puede provocar lesiones auditivas.

## Uso di BeoRemote One

Il televisore può essere comandato con il BeoRemote One, come descritto qui, nella guida del prodotto e nella guida online disponibile su [www.bang-olufsen.com/guides](http://www.bang-olufsen.com/guides). La guida offre informazioni sui collegamenti, la configurazione, le caratteristiche e le funzioni.



-  **TV** Il display visualizza un elenco di fonti o funzioni quando viene acceso
-  **TV** Attiva il televisore dallo standby e visualizza le fonti del televisore disponibili e attivabili sul display. Utilizzare  $\wedge$  oppure  $\vee$  per scorrere l'elenco\*
-  **MUSIC** Visualizza le fonti musicali disponibili e attivabili sul display. Utilizzare  $\wedge$  oppure  $\vee$  per scorrere l'elenco\*
-  **MyButtons.** Premere a lungo per memorizzare la configurazione corrente, come le fonti e le impostazioni audio e video. Premere brevemente per selezionarlo
-  **0-9** Consente di selezionare canali e immettere informazioni nei menu a schermo
-  **LIST** Visualizza funzioni aggiuntive sul display. Utilizzare  $\wedge$  oppure  $\vee$  per scorrere l'elenco
-  **GUIDE** Richiama la Guida dei programmi del televisore
-  Consente di tornare indietro nei menu e negli elenchi del BeoRemote One
-  **INFO** Richiama testi descrittivi e informazioni su un menu o una funzione
-  Richiama il menu Home e visualizza le app disponibili
-  **< > &wedge; &vee;** Tasti freccia sinistro, destro, su e giù  $\wedge$ ,  $\vee$  e  $\vee$ . Consentono di spostarsi nei menu e nel display di BeoRemote One
-  **Il tasto centrale** viene utilizzato per selezionare e attivare fonti, funzioni e impostazioni
-  Seleziona funzioni specifiche correlate ai colori
-  Avvia la riproduzione di un brano, di un file o di una registrazione o avvia il replay
-  Consente di scorrere in avanti o indietro, passo dopo passo
-  **P +/-** Consente di scorrere canali o emittenti
-  **II** Consente di interrompere la riproduzione di un programma o di una registrazione
-  **🔊 +/-** Regola il volume. Per disattivare l'audio, premere la parte centrale del tasto
-  **Standby**

**Importante** – le guide sono disponibili su [www.bang-olufsen.com/guides](http://www.bang-olufsen.com/guides)

**\*Fonti del BeoRemote One** Alcune fonti del display possono essere reimpostate durante il processo di configurazione. Per ulteriori informazioni, vedere la guida interna del televisore.  
 NOTA: per informazioni generali sull'uso del telecomando, vedere la guida fornita con il telecomando.

Per comandare il televisore con il BeoRemote One, i due apparecchi devono essere abbinati. Per abilitare il televisore per l'abbinamento, è necessario prima collegarlo alla rete elettrica.\*\* Per informazioni su come abbinare il telecomando al televisore, consultare la guida online del BeoRemote One. Vedere inoltre la guida del televisore per ulteriori informazioni sull'abbinamento.

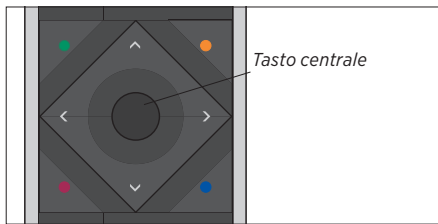

Usare <, >, ^ e v per esplorare il menu Home del televisore, i menu e il display del BeoRemote One. Per esempio, è possibile usare < e > per cambiare il formato dell'immagine. Premere il tasto **centrale** per confermare le selezioni nel menu Home e nei menu e le impostazioni nei menu. Per tornare indietro nei menu, premere ←. Per ulteriori informazioni, consultare la guida del BeoRemote One.

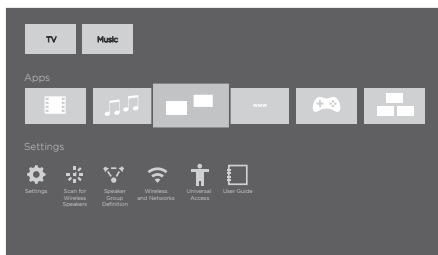

Esempio di un menu Home.

Utilizzare ☰ per richiamare il menu Home del televisore. Da qui, è possibile accedere e scaricare una grande varietà di app diverse. Qui è inoltre possibile trovare le app predefinite per le funzioni del televisore, come per esempio per il menu delle impostazioni del televisore. Per ulteriori informazioni, vedere la guida interna del televisore.

È possibile richiamare la guida interna del televisore premendo il tasto **blu** quando è disponibile nei menu.

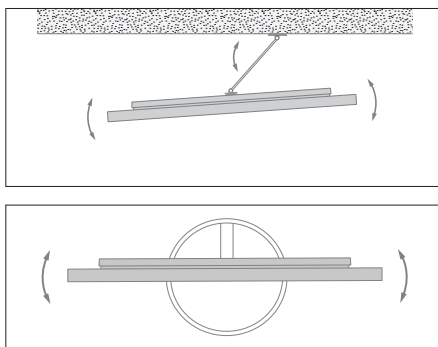

Se il televisore è dotato della staffa da parete o stand da pavimento opzionali, è possibile ruotarlo manualmente. Per ulteriori informazioni sulla staffa da parete, vedere la guida per la staffa da parete. Per ulteriori informazioni sullo stand da pavimento, vedere la guida per lo stand da pavimento.

#### \*\*Abbinamento Bluetooth del BeoRemote One

Se il televisore viene scollegato dalla rete elettrica e poi ricollegato, entrerà in modalità abbinamento Bluetooth per l'abbinamento di un BeoRemote One. Notare che, per poter abbinare i due prodotti, sia il televisore sia il telecomando devono essere in modalità abbinamento. Vedere la guida del BeoRemote One.













Avvertimento: l'ascolto prolungato ad alto volume (oltre 85 dB) può danneggiare l'udito!

## Как пользоваться пультом дистанционного управления

### Управление с помощью BeoRemote One

Вы можете управлять своим телевизором с помощью пульта BeoRemote One, как описано здесь, в руководстве на устройстве и в онлайн-руководстве, доступном на [www.bang-olufsen.com/guides](http://www.bang-olufsen.com/guides). Руководство содержит сведения о соединениях, настройках, характеристиках и функциях.



-  **TV** При включении на этом дисплее отображается список источников или функций
-  **TV** Включение телевизора из режима ожидания и отображение на дисплее доступных для включения телевизионных источников. Используйте ^ или v для перехода по списку\*
-  **MUSIC** Отображение на дисплее доступных для включения музыкальных источников. Используйте ^ или v для перехода по списку\*
-  **MyButtons.** Нажмите и удерживайте для сохранения текущей системы настроек, например, источника, настроек звучания и изображения. Нажмите, чтобы выбрать систему настроек
-  **0–9** Выбор каналов и ввод информации в экранном меню
-  **LIST** Отображение на дисплее дополнительных функций. Используйте ^ или v для перехода по списку
-  **GUIDE** Вызов телевизионного справочника передач
-  **←** Выход или перемещение назад по меню и в списках BeoRemote One
-  **INFO** Вызов справки и информации о меню или функции
-  **⌂** Вызов Главного меню и отображение доступных приложений
-  **< > ^ v** Кнопки со стрелками для перехода влево, вправо, вверх и вниз <, >, ^ и v. Перемещение в меню и на дисплее BeoRemote One
-  **Центральная** кнопка используется для выбора и активации источников, функций и настроек
-  **Выбор специальных функций,** закрепленных за цветными кнопками
-  **▶** Воспроизведение или повторное воспроизведение трека, файла или записи
-  **⏮ ⏭** Поиск с пошаговым перемещением назад или вперед
-  **P +/-** Переход между каналами или станциями
-  **⏸** Остановка воспроизведения передачи или записи
-  **🔊 +/-** Регулировка громкости. Для отключения звука нажмите на середину кнопки
-  **⏻** Режим ожидания

**Внимание** – руководства находятся по адресу [www.bang-olufsen.com/guides](http://www.bang-olufsen.com/guides)

**\*Источники BeoRemote One** Некоторые источники, отображаемые на дисплее, можно перенастроить в процессе установки. См. руководство на экране телевизора для получения дополнительной информации.  
**ПРИМЕЧАНИЕ!** Для получения общих сведений о работе пульта дистанционного управления см. руководство по его использованию.



Чтобы управлять телевизором с помощью пульта BeoRemote One, он должен быть сопряжен с телевизором. Для выполнения сопряжения с телевизором сначала подключите его к электрической сети.\*\* См. онлайн-руководство BeoRemote One для получения информации о том, как выполнить его сопряжение с телевизором. Кроме того, смотрите руководство на экране телевизора для получения дополнительной информации о сопряжении.



Нажимайте <, >, ^ и v для навигации по Главному меню телевизора, по меню и на дисплее BeoRemote One. Например, вы можете использовать < и > для изменения формата изображения. Нажимайте **центральную** кнопку для подтверждения выбора в Главном меню, в других меню и для сохранения настроек в меню. Для выхода или возврата к предыдущим меню нажмите ←. Для получения дополнительной информации см. руководство к вашему пульту дистанционного управления BeoRemote One.

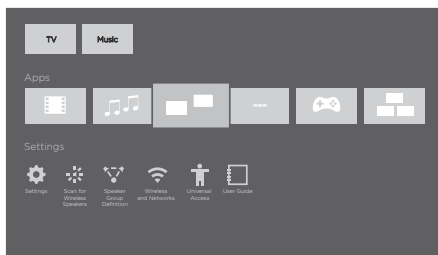

Пример Главного меню.

Используйте , чтобы вызвать Главное меню телевизора. Из него вы можете получить доступ и загрузить множество разных приложений. Кроме того, здесь вы найдете готовые приложения для телевизионных функций, например, для меню настроек телевизора. Дополнительные сведения см. в руководстве на экране телевизора.

Вы можете вызвать руководство на устройстве, нажав **синюю** кнопку в доступных меню.

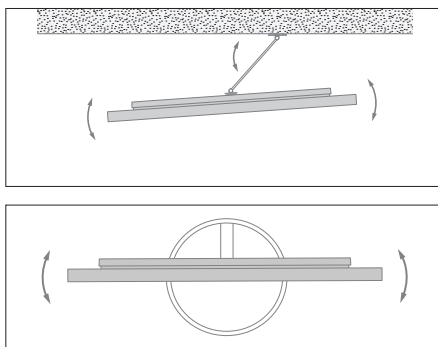

Если ваш телевизор оснащен отдельно приобретаемым настенным кронштейном или напольной подставкой, вы можете поворачивать его вручную. Дополнительную информацию о настенном кронштейне см. в руководстве к настенному кронштейну. Дополнительную информацию о напольной подставке см. в руководстве к напольной подставке.

### \*\*Сопряжение пульта BeoRemote One по Bluetooth

Если телевизор отключить от сети, а затем снова подключить, он перейдет в режим сопряжения по Bluetooth, чтобы вы могли выполнить сопряжение с BeoRemote One. Учтите, что и телевизор, и пульт дистанционного управления должны находиться в режиме сопряжения, чтобы вы могли сопрячь эти два продукта. См. руководство к BeoRemote One.

Предупреждение: Продолжительное прослушивание на высокой громкости (более 85 дБ) может повредить слух!

## BeoRemote One 操作

您可以按照此处、产品随附和在线指南(网址为 [www.bang-olufsen.com/guides](http://www.bang-olufsen.com/guides))中的说明使用 BeoRemote One 对电视机进行操作。指南提供了有关连接、设置、特性和功能的信息。



-  **TV** 打开显示屏时，将显示出一个信号源或功能列表
-  **TV** 将电视机从待机模式打开，显示屏会显示可用的电视机信号源以供您打开。使用  $\wedge$  或  $\vee$  在列表上移动浏览\*
-  **MUSIC** 在显示屏中显示可用的音乐信号源以供您打开。使用  $\wedge$  或  $\vee$  在列表上移动浏览\*
-  我的按键长按可存储当前设置，如信号源、声音和图像设置等。短按可进行选定
-  **0-9** 在屏幕菜单上选择频道并输入数据
-  **LIST** 在显示屏中显示附加功能。使用  $\wedge$  或  $\vee$  在列表上移动浏览
-  **GUIDE** 调出电视节目指南
-  **←** 退出或返回菜单和 BeoRemote One 列表的上一页
-  **INFO** 调出帮助文本以及有关菜单或功能的信息
-  **⌂** 调出主菜单和显示可用的应用程序
-  **< >** 箭头按键左、右、上、下:  $\lt$ 、 $\gt$ 、 $\wedge$  和  $\vee$ 。在菜单和 BeoRemote One 显示屏中移动
-  用于选择和激活信号源、功能和设置的中心按键。
-  选择色彩特定功能
-  **▶** 开始播放曲目、文件或录制内容，或者开始重新播放
-  **⏮ ⏭** 逐步向后或向前搜索
-  **P +/-** 浏览频道或电台
-  **⏸** 暂停播放节目或录制内容
-  **🔊 +/-** 调节音量。如需静音，请按此按键中间
-  **⏻** 待机

**重要提示** - 用户可以在 [www.bang-olufsen.com/guides](http://www.bang-olufsen.com/guides) 上获取指南

\*BeoRemote One 信号源 显示屏中的某些信号源可在设置过程中进行重新配置。如需了解更多信息，请参阅电视机随附指南。注意！如需了解有关遥控器操作的通用信息，请参阅遥控器指南。

要使用 BeoRemote One 操作电视机，必须对这两者进行配对。要打开电视机的配对功能，首先必须将电视机连接电源。**\*\*** 关于如何实现电视机与 BeoRemote One 的配对，请参见 BeoRemote One 在线指南。此外，欲了解有关配对的详细内容，请参见电视机随附指南。

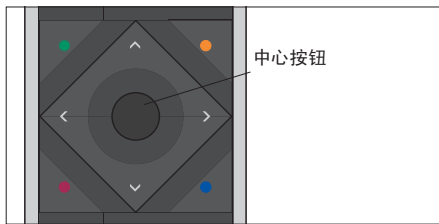

使用 <、>、^ 和 v 在电视机主菜单、菜单和 BeoRemote One 显示屏中导航。例如可使用 < 和 > 更改画面格式。按中心按钮在主菜单和菜单中确认选择和设置。若要退出或返回上一菜单，请按 ←。欲了解更多信息，请参见 BeoRemote One 遥控器指南。

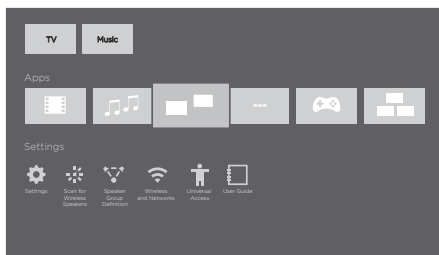

主菜单的示例。

使用 □ 调出电视机主菜单。您可以从此处访问和下载各种应用程序。您也可以从此处找到针对电视机特性的预定义应用程序，例如电视机设置菜单。欲了解更多信息，请参见电视机的指南。

在菜单中的蓝色按钮可用时按下它，即可调出产品随附指南。

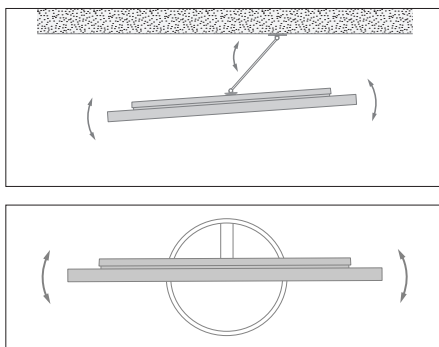

如果您的电视配有可选墙托架，您可以手动转动电视。如需了解更多有关墙托架的信息，请参阅墙托架指南。如需了解更多有关落地脚架的信息，请参阅落地脚架指南。

#### **\*\*BeoRemote One 蓝牙配对**

断开电视机电源又重新连接，即可进入蓝牙配对模式，执行电视机与 BeoRemote One 的配对。请注意，电视机和遥控器都必须处于配对模式才能进行配对。请参见 BeoRemote One 指南。

**警告：**长时间收听高音量声音（超过 85dB）有损害听力之虞！

### IMPORTANT INFORMATION

If a television is not positioned in a sufficiently stable location, it can be potentially hazardous due to falling. Many injuries, particularly to children, can be avoided by taking simple precautions such as:

- Using cabinets or stands recommended by the manufacturer of the television.
- Only using furniture that can safely support the television.
- Ensuring the television is not overhanging the edge of the supporting furniture.
- Not placing the television on tall furniture, (for example, cupboards or bookcases) without anchoring both the furniture and the television to a suitable support.
- Not standing the television on cloth or other materials placed between the television and supporting furniture.
- Educating the children about the dangers of climbing on furniture to reach the television or its controls.



Electrical and electronic equipment, parts and batteries marked with this symbol must not be disposed of with normal household waste, it must be collected and disposed of separately to protect the environment.

Your Bang & Olufsen retailer will advise you of the correct way of disposal in your country.



For indoor use only.

Hereby, Bang & Olufsen declares that this product is in compliance with the essential requirements and other relevant provisions of Directive 1999/5/EC. The declaration of conformity may be consulted at [www.bang-olufsen.com/guides](http://www.bang-olufsen.com/guides).

This product incorporates copyright protection technology that is protected by U.S. patents and other intellectual property rights. Use of this copyright protection technology must be authorized by Rovi Corporation, and is intended for home and other limited viewing uses only unless otherwise authorized by Rovi Corporation. Reverse engineering or disassembly is prohibited.

HDMI, the HDMI Logo and High-Definition Multimedia Interface are trademarks or registered trademarks of HDMI Licensing LLC.

The Bluetooth® word mark and logos are registered trademarks owned by Bluetooth SIG, Inc. and any use of such marks by Bang & Olufsen is under license. Other trademarks and trade names are those of their respective owners.

#### **Important!**

- Avoid placing the product in direct sunlight or direct artificial light, such as a spotlight.
- Make sure that the product is set up, placed and connected in accordance with the instructions.
- Place your product on a firm surface or stand where you want it placed permanently. Use Bang & Olufsen approved stands and wall brackets only!
- Do not place any items on top of your product.
- Do not subject the product to high humidity, rain or sources of heat.
- The product is intended for indoor use in dry, domestic environments only. Use within a temperature range of 10–40°C (50–105°F).
- Leave enough space around the product for adequate ventilation.
- Do not connect any of the products in your system to the mains, until you have connected all the cables.



Manufactured under license from Dolby Laboratories. Dolby and the double-D symbol are trademarks of Dolby Laboratories.



For DTS patents, see <http://patents.dts.com>. Manufactured under license from DTS Licensing Limited. DTS, the Symbol, DTS in combination with the Symbol, and DTS Digital Surround are registered trademarks or trademarks of DTS, Inc. in the United States and/or other countries. © DTS, Inc. All Rights Reserved.

- Do not attempt to open the product. Leave such operations to qualified service personnel.
- The product can only be switched off completely by disconnecting it from the wall socket.
- The supplied plug and mains cord are specially designed for the product. Do not change the plug and if the mains cord is damaged, you must buy a new one from your Bang & Olufsen retailer.

**WARNING:** To reduce the risk of fire or electric shock, do not expose this appliance to rain or moisture. Do not expose this equipment to dripping or splashing and ensure that no objects filled with liquids, such as vases, are placed on the equipment. To completely disconnect this equipment from the AC Mains, disconnect the mains plug from the wall socket. The wall socket must always be easily accessible.



Elektrisk og elektronisk udstyr, reservedele og batterier, der er mærket med dette symbol, må ikke bortskaffes sammen med almindeligt husholdningsaffald. Det skal indsamles og bortskaffes separat for at beskytte miljøet.

Din Bang & Olufsen forhandler kan rådgive dig om den korrekte bortskaffelsesmetode i dit land.



Kun beregnet til indendørsbrug.

Bang & Olufsen erklærer hermed, at dette produkt overholder de essentielle krav og relevante bestemmelser i direktivet 1999/5/EF. Se også overensstemmelseserklæringen på [www.bang-olufsen.dk/brugervejledninger](http://www.bang-olufsen.dk/brugervejledninger).

#### Vigtigt!

- Anbring ikke produktet i direkte sollys eller direkte under kunstig belysning, f.eks. en spot.
- Sørg for, at produktet sættes op, placeres og tilsluttes i overensstemmelse med instruktionerne.
- Placer produktet på en solid overflade eller stand, hvor du ønsker, det skal blive stående. Brug kun stande og vægbeslag, der er godkendt af Bang & Olufsen.
- Anbring ikke genstande oven på produktet.
- Udsæt ikke produktet for høj luftfugtighed, regn eller varme.
- Produktet er udelukkende beregnet til indendørsanvendelse under tørre forhold inden for et temperaturområde på 10-40 °C.
- Sørg for, at der er plads nok omkring produktet til at sikre tilstrækkelig ventilation.
- Slut ikke nogen af produkterne i dit system til lysnettet, før du har tilsluttet alle kablerne.

- Forsøg aldrig at åbne produktet. Produktet må kun åbnes af uddannede serviceteknikere.
- Produktet kan kun slukkes helt ved at tage stikket ud af stikkontakten.
- Den medfølgende netledning og stikket på den er specielt designet til dette produkt. Stikket må ikke ændres, og hvis netledningen bliver beskadiget, skal du købe en ny hos din Bang & Olufsen forhandler.
- ADVARSEL: For at reducere risikoen for brand og elektrisk stød må dette produkt ikke udsættes for regn eller fugt. Produktet må heller ikke udsættes for dryp eller stænk, og der må ikke placeres genstande fyldt med væske, f.eks. vaser, på udstyret. Tag stikket ud af stikkontakten for helt at afbryde strømmen til produktet. Afbryderen skal altid være nem at komme til.



Mit diesem Symbol gekennzeichnete elektrische und elektronische Geräte, Bauteile und Batterien dürfen nicht in den normalen Haushaltsmüll gegeben, sondern müssen zum Schutz der Umwelt sämtlich getrennt eingesammelt und entsorgt werden.

Ihr Bang & Olufsen Fachhändler berät Sie bei der sachgerechten Entsorgung in Ihrem Land.



Nicht für den Gebrauch im Freien.

Hiermit erklärt Bang & Olufsen, dass dieses Produkt den wesentlichen Anforderungen und sonstigen relevanten Bestimmungen der Richtlinie 1999/5/EC entspricht. Die Konformitätserklärung finden Sie unter [www.bang-olufsen.com/guides](http://www.bang-olufsen.com/guides).

#### Wichtiger Hinweis:

- Stellen Sie das Gerät nicht in direktem Sonnenlicht oder nahe an direkten künstlichen Lichtquellen wie Spots auf.
- Achten Sie darauf, dass das Gerät entsprechend diesen Hinweisen platziert, angeschlossen und eingestellt wird.
- Stellen Sie das Gerät auf einer festen Oberfläche oder einem soliden Standfuß an dem Ort auf, wo es auf Dauer verbleiben soll. Benutzen Sie nur von Bang & Olufsen zugelassene Standfüße und Wandhalterungen!
- Stellen Sie keine Gegenstände auf das Gerät.
- Setzen Sie das Gerät nicht hoher Feuchtigkeit, Regen und Wärmequellen aus.
- Das Gerät ist ausschließlich für den Gebrauch in trockenen Wohnräumen vorgesehen. Die zulässige Umgebungstemperatur im Betrieb beträgt zwischen 10 und 40 °C.
- Lassen Sie um das Gerät stets genug Platz für ausreichende Lüftung.

- Schließen Sie keines der Geräte in Ihrem System an das Netz an, bevor Sie alle anderen Kabel angeschlossen haben.
- Versuchen Sie nicht, das Gerät zu öffnen. Überlassen Sie dies qualifiziertem Servicepersonal.
- Das Gerät kann nur durch Netztrennung vollständig ausgeschaltet werden.
- Das mitgelieferte Netzkabel samt Stecker wurde speziell für dieses Produkt entwickelt. Tauschen Sie den Stecker nicht aus. Wenn das Netzkabel beschädigt wird, müssen Sie bei Ihrem Bang & Olufsen Fachhändler ein neues anfordern.
- ACHTUNG: Um Feuer oder elektrische Schläge zu vermeiden, darf dieses Gerät weder Regen noch Feuchtigkeit ausgesetzt werden. Setzen Sie dieses Gerät keinem Tropf- bzw. Spritzwasser aus und stellen Sie keine mit Flüssigkeiten gefüllten Objekte wie z. B. Vasen darauf ab.
- Um das Gerät vollständig vom Netz zu trennen, ziehen Sie den Netzstecker aus der Steckdose. Die Steckdose sollte frei zugänglich bleiben.



Il n'est pas permis de jeter les équipements, les pièces électriques et électroniques et les batteries portant ce symbole avec les ordures ménagères ; ces équipements doivent être collectés et mis au rebut séparément afin de préserver l'environnement.

Votre revendeur Bang & Olufsen se fera un plaisir de vous conseiller sur la procédure correcte de mise au rebut dans votre pays.



Uniquement destiné pour une utilisation à l'intérieur.

Bang & Olufsen déclare par la présente que le présent produit, est conforme aux exigences essentielles et aux autres dispositions de la Directive 1999/5/EC. La déclaration de conformité peut être consultée à l'adresse suivante : [www.bang-olufsen.com/guides](http://www.bang-olufsen.com/guides).

#### Important !

- Eviter d'exposer directement l'appareil au soleil ou à la lumière artificielle (spots, etc.).
- Vérifier que l'appareil est installé, positionné et connecté conformément aux instructions.
- Poser l'appareil sur une surface ferme, de préférence sur une table, un buffet ou un pied, où il restera en permanence. N'utiliser que les pieds et les supports muraux agréés par Bang & Olufsen !
- Ne poser aucun objet sur l'appareil.
- Ne pas exposer l'appareil à un taux d'humidité élevé, à la pluie ou à une source de chaleur.
- Cet appareil est uniquement conçu pour être utilisé à l'intérieur, dans un lieu sec. Plage de températures acceptable : 10 à 40 °C.
- Laisser suffisamment d'espace autour de l'appareil pour une ventilation appropriée.
- Ne relier aucun élément de l'installation au secteur avant d'avoir branché tous les câbles.

- Ne pas tenter d'ouvrir le boîtier de l'appareil. Les opérations de ce type doivent être confiées à du personnel de maintenance qualifié.
- Pour éteindre complètement l'appareil, la seule possibilité est de débrancher la prise murale.
- Le câble secteur et la fiche fournis sont spécialement conçus pour cet appareil. Ne pas changer la fiche. Si le câble secteur est endommagé, en acheter un autre auprès de votre revendeur Bang & Olufsen.
- AVERTISSEMENT : afin de réduire le risque d'incendie ou d'électrocution, ne pas exposer cet appareil à la pluie ou à l'humidité. Ne pas exposer l'appareil à l'écoulement de liquides et aux éclaboussures et s'assurer qu'aucun objet rempli de liquide, par exemple un vase, n'est placé sur l'appareil.
- Pour déconnecter complètement l'appareil du secteur, débrancher le cordon d'alimentation de la prise secteur. L'appareil débranché reste prêt à l'emploi.



Los equipos, piezas y baterías de tipo eléctrico y electrónico marcados con este símbolo no deben eliminarse junto con los residuos domésticos habituales; en su lugar, deben ser recogidos y eliminados de forma independiente para proteger el medioambiente.

Su distribuidor de Bang & Olufsen le asesorará acerca de los pasos a seguir en su país para realizar la eliminación de forma correcta.



Este equipo está destinado exclusivamente al uso en interiores.

Bang & Olufsen declara que este equipo satisface los requisitos fundamentales y demás disposiciones correspondientes de la Directiva 1999/5/CE. La declaración de conformidad está disponible públicamente en el sitio web: [www.bang-olufsen.com/guides](http://www.bang-olufsen.com/guides).

#### **Importante**

- Evite colocar el equipo en un lugar expuesto a la luz solar directa o a luz artificial directa, como la generada por un foco halógeno.
- Asegúrese de que el equipo permanezca instalado, situado y conectado de acuerdo con las instrucciones.
- Coloque el equipo sobre una superficie firme o en un soporte apto para su instalación permanente. Use exclusivamente soportes de pie y de pared homologados por Bang & Olufsen.
- No coloque ningún objeto sobre el equipo.
- No someta el equipo a niveles elevados de humedad, a la lluvia o a fuentes de calor.
- Este equipo ha sido diseñado exclusivamente para el uso interior en entornos domésticos secos. El uso debe tener lugar a una temperatura comprendida entre 10 y 40 °C (50 y 105 °F).
- Mantenga el espacio necesario alrededor del equipo para favorecer su correcta ventilación.
- No conecte ninguno de los equipos del sistema a la red eléctrica hasta que haya conectado todos los cables.

- No intente abrir el equipo. Este tipo de operaciones debe ser realizado por personal técnico cualificado.
  - El equipo sólo se puede apagar totalmente desconectando el enchufe de la toma de suministro eléctrico.
  - El enchufe y el cable de alimentación suministrados han sido diseñados especialmente para este equipo. No cambie el enchufe; si el cable de alimentación resulta dañado, deberá adquirir otro a través de su distribuidor de Bang & Olufsen.
- ADVERTENCIA: A fin de reducir el riesgo de incendio o descarga eléctrica, no exponga este aparato a la lluvia ni a la humedad. No exponga este equipo a goteos o salpicaduras ni coloque ningún objeto que contenga líquido, como un jarrón, sobre el mismo. Para desconectar completamente este equipo de la red eléctrica de corriente alterna, desconecte el enchufe de alimentación de la toma de suministro eléctrico. El dispositivo de desconexión debe encontrarse en un lugar fácilmente accesible.



Apparecchiature elettriche ed elettroniche, parti e batterie, contrassegnate con questo simbolo non devono essere smaltite con i normali rifiuti domestici, ma devono essere raccolte e smaltite separatamente per proteggere l'ambiente.

Per informazioni sulla procedura di smaltimento corretta per il proprio Paese, rivolgersi a un rivenditore Bang & Olufsen.



Inteso solo per uso al coperto.

Con la presente, Bang & Olufsen dichiara che questo prodotto, è conforme ai requisiti essenziali e altre disposizioni esposte nella Direttiva 1999/5/EC. La Dichiarazione di conformità può essere consultata all'indirizzo [www.bang-olufsen.com/guides](http://www.bang-olufsen.com/guides).

#### **Importante!**

- Non esporre il prodotto alla luce del sole o artificiale (ad esempio un faretto) diretta.
- Verificare che il prodotto sia stato installato, posizionato e collegato in conformità con le istruzioni fornite.
- Posizionare il prodotto su una superficie stabile o altra collocazione permanente. Utilizzare solo stand e staffe da parete approvati da Bang & Olufsen.
- Non posare oggetti sopra il prodotto.
- Non esporre il prodotto a valori elevati di umidità, a pioggia o a fonti di calore.
- Il prodotto è inteso solo per un uso in ambienti domestici e privi di umidità. Utilizzare a temperature comprese tra 10° e 40° C.
- Lasciare spazio sufficiente intorno al prodotto per consentirne una ventilazione adeguata.
- Non collegare nessuno dei singoli dispositivi dell'impianto alla rete di alimentazione prima di aver collegato tutti i cavi.

- Non tentare di aprire il prodotto. Queste operazioni sono esclusivamente di competenza del personale tecnico qualificato.
  - Il prodotto può essere spento completamente solo scollegandolo dalla presa a muro.
  - Il cavo dell'alimentazione e la relativa spina in dotazione sono stati progettati specificamente per il prodotto. Non sostituire la spina e, se il cavo dovesse subire danni, è necessario acquistarne uno nuovo da un rivenditore Bang & Olufsen.
- ATTENZIONE: per evitare il rischio di incendi o scariche elettriche, non esporre questo apparecchio a pioggia o umidità. Non esporre l'apparecchio a gocciolii o spruzzi e non collocare oggetti contenenti liquidi, ad esempio vasi, sopra di esso. Per scollegare completamente l'apparecchio dall'alimentazione CA, scollegare il cavo dell'alimentazione dalla presa a muro. Il dispositivo scollegato rimarrà pronto per l'uso.



35114681606000



