

BeoSound Shape

Amplifier and empty tile
Type 6307

Speaker tile
Type 6308

Acoustic damper tile
Type 6071

Fabric cover
Type 6072

Installation Guide
English - version 1.2

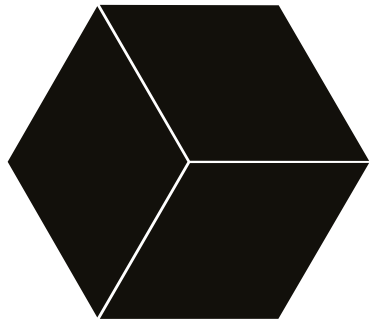

Introduction

BeoSound Shape is a unique scalable wireless speaker system that can be customised and turn high-quality music into an interior art form. It is designed as a modular combination of hexagonal shapes that are combined in a wall decoration, which can be placed on the wall in the size and pattern you prefer. It consists of a combination of speakers, amplifiers, damper and empty tiles that you can combine in different patterns, fabrics and colours. The amplifier tile contains the electronics. This tile can drive up to 4 speaker tiles. Each speaker tile includes two driver units; one ¾-inch tweeter and a 5 1/4-inch bass/midrange unit.

The speaker system is meant to be set up together with a BeoSound Core, but the amplifier tile together with some speaker tiles can also be connected to other audio sources via Power Link or Optical In.

Embedding BeoSound Core you are able to wirelessly stream high-quality music from your mobile device via the latest streaming technologies such as AirPlay, Google Cast or Bluetooth. You also have the BeoLink Multiroom functionality making BeoSound Shape part of the family of products that can play different music in different rooms or let one tune flow throughout your home.

A special cable solution means that although it is an active speaker design with one amplifier per driver, you only need one cable per speaker tile, and you can combine several amplifier and speaker tiles in one coherent system and thereby increase the sound performance. You simply daisy chain from one amplifier tile to the next. You will have tiles that have no speakers or electronics inside but which bind the design into a coherent look and may be hiding BeoSound Core, dampening materials, the cabling or the mains outlet.

There are practically no limitations as to the number of tiles you can have in a design, but we have tested a setup with 44 speaker tiles. Each amplifier tile includes eight amplifiers of each 80 watts so the performance of the system depends on the number of amplifier and speaker tiles you have. Each amplifier tile can drive up to four speaker tiles.

A star rail, which has to hold the design, is easily clicked together with connector rails to create the pattern you want on the plain and vertical wall. This means you can create the placement of the tiles e.g. on the floor before you mount the system on the wall. The star rail is screwed into the wall, and then you start mounting the tiles with the electronics, the drivers and the cabling. The cabinet hold the cabling in place so the installation looks neat. The Bang & Olufsen logo badge is created as an attachment in aluminium. The badge can easily be clicked onto one of the star rail connectors.

The speaker system is designed by the customer in the Configuration Tool on www.bang-olufsen.com. The design is stored on a BeoCloud account, and a PDF with details is created. When the BeoSound Shape is mounted on the customer's wall, the Bang & Olufsen app is used to setup the system with the configuration specialised for exactly this design.

How to use this installation guide

Use this installation guide together with the installation video on <https://bang-olufsen.zendesk.com/hc/en-us/articles/360042003831>



This installation guide and the video give an introduction to the product and step-by-step instructions on how to:

- Mount the BeoSound Shape on the wall.
For correct placement on the wall and for placement of the wall socket, see Placement Tool on <https://shapeinstaller.bang-olufsen.com/>
- First-time setup and setup of additional speakers, services and settings.
- Troubleshooting
- Other 'nice to know' subjects are dealt with. Also the connector specifications are shown.





Introduction
How to use this installation guide
Navigation in this guide!
Navigation TIP
BeoSound Shape
Connection panel
Mounting
Mounting star rails
Mounting Bang & Olufsen logo badge
Mounting the tiles
Connecting cables
First time setup
Mount fabric cover
How to upgrade an existing BeoSound Shape
Alternative Setup
Software update
Automatic software update
Web interface access to the BeoSound Shape
Troubleshooting
LED indications
Technical specifications
Connectivity (provided by BeoSound Core)
Connection specifications
Table of Contents

Navigation in this guide

When the guide is opened, it automatically opens in Full Screen Mode (can be left as desired - see below). This is primarily done to optimise the usability of screen reading. There are several ways to navigate when using the guide, see the survey of keys, shortcuts and hot keys below:

-  (arrow keys on the keyboard) navigates to the next page
-  (arrow keys on the keyboard) navigates to the previous page
-  (**Esc** button) exits Full Screen Mode (press **Ctrl + L** to return to Full Screen Mode).

Another feature to optimise the navigation is the navigation icons at the bottom of the screen (see below for explanation).

-  Navigates you to the previous view
-  Navigates you directly to the start page
-  Navigates directly to the table of contents (these are active links - click the link to be directed directly to the associated section)
-  Prints the document - the print dialogue box opens (**Ctrl + P** also brings up this feature)

Navigation TIP

The right side of this page and the Table of Contents, page 44, act as an active table of contents. Simply click the subject you want, and you are transferred to the section in question.

BeoSound Shape

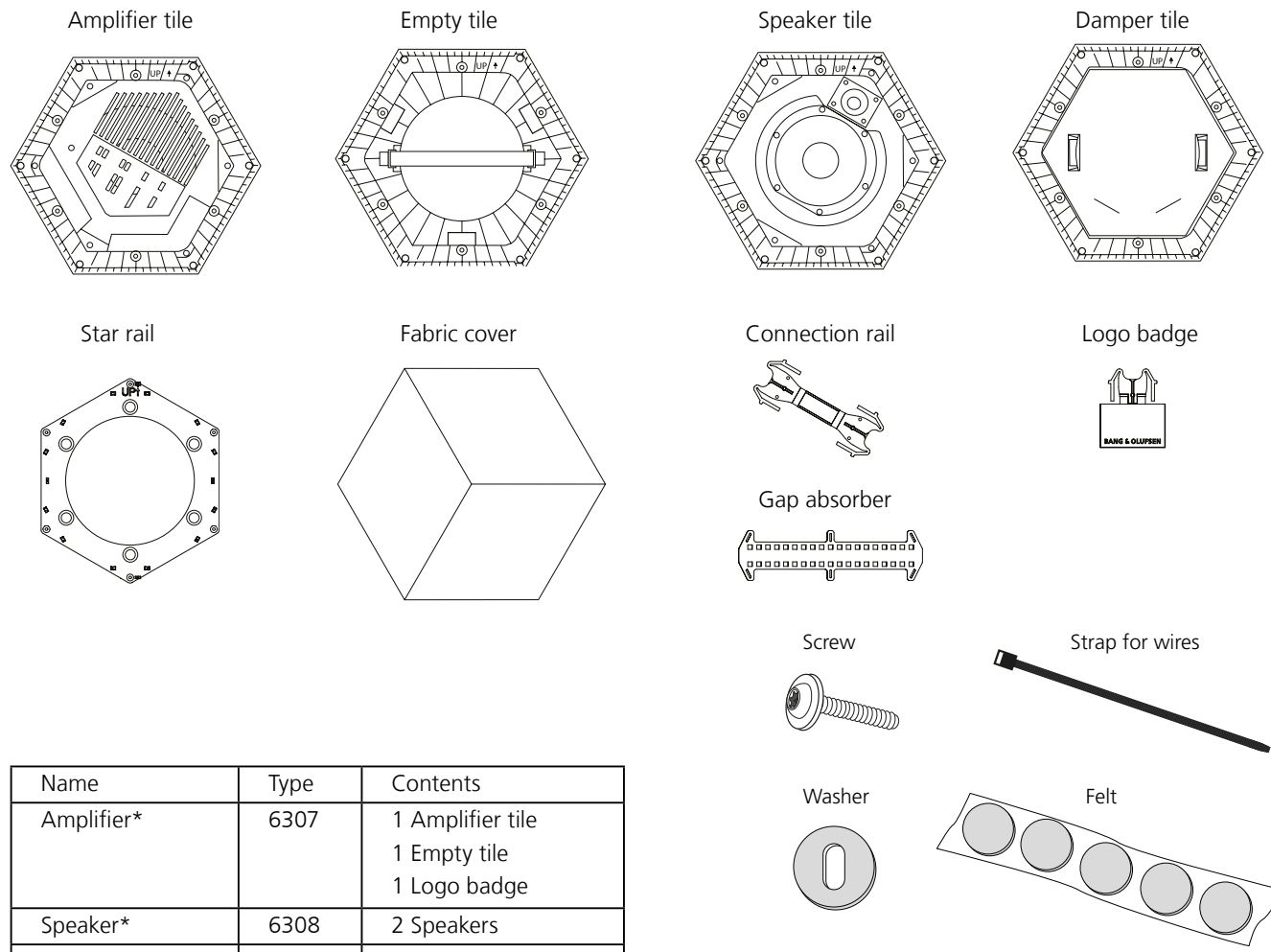

What is in the package?

Name	Type	Contents
Amplifier*	6307	1 Amplifier tile 1 Empty tile 1 Logo badge
Speaker*	6308	2 Speakers
Damper*	2997	2 Dampers
Fabric cover	6072	2 Fabric covers

* Also includes: 2 star rails, 4 connection rails, 4 gap absorbers, 5 felt stickers, 2 straps for wires, 12 PT3x18 torx 10 zink screws, 12 washers

Connection panel

Amplifier tile:

- OPTICAL-IN Digital audio input
- 🔌 USB USB for control and SW update
- COMM IN Amplifier input (sound & control input), for daisy chaining of amplifiers
- COMM OUT Amplifier output (sound & control output), for daisy chaining of amplifiers
- POWER LINK Power Link input
- 1-4 4 x speaker 4-wire output
- ⚡ AC power (note if multiple amplifiers, each requires its own AC power connection)

Speaker tile:

- 1 x speaker 4-wire input

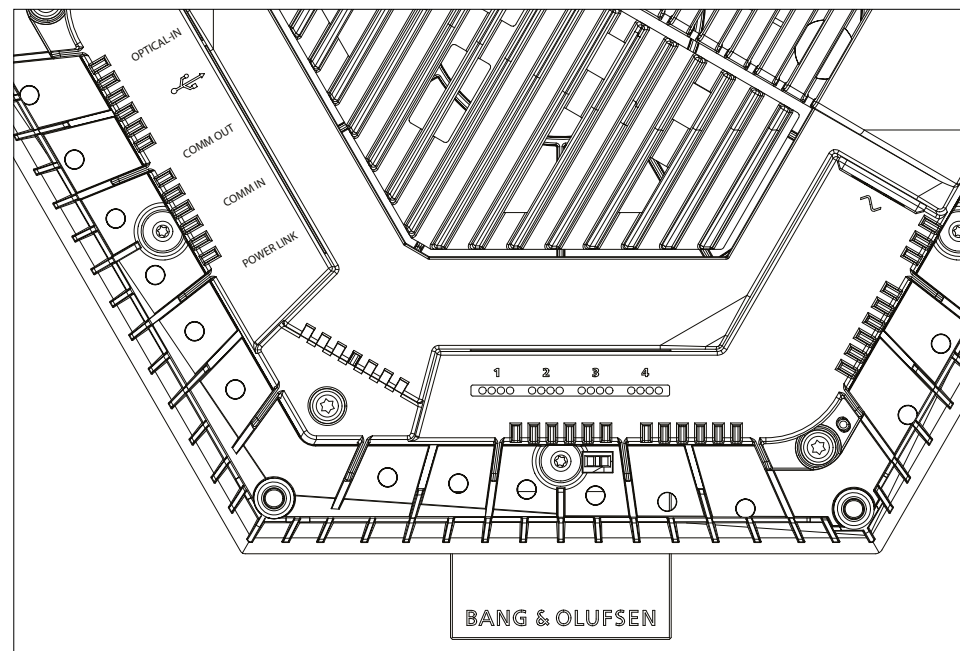

Mounting

Before mounting the BeoSound Shape please see the installations video on <https://bang-olufsen.zendesk.com/hc/en-us/articles/360042003831> and the Placement Tool on <https://shapeinstaller.bang-olufsen.com/>

Placement Tool

To make the installation of the BeoSound Shape easier, we have made a Placement Tool. This tool will help the installer decide where to place the wall socket. Furthermore, it will be possible to decide where to place the first screw in the first star rail. If there are any obstacles on the customer's wall, it is also possible to calculate how to avoid these.

First the installer has to draw the design in the Placement Tool. The tool is based on a coordinate system, where you can enter your measurements. It is possible to change all the measurements in blue colour, just click on the value. When the design is made, and the correct measurements are entered in the tool, it is possible to click on every star rail to get an option menu. From the menu you can get the top screw position ('Star rail mounting dimensions') and the centre position ('Star rail socket position') of the star rail. It is also possible to remove a star rail or simulate what should be mounted onto the star rail.

The tool is web-based and can be found here: <https://shapeinstaller.bang-olufsen.com/>

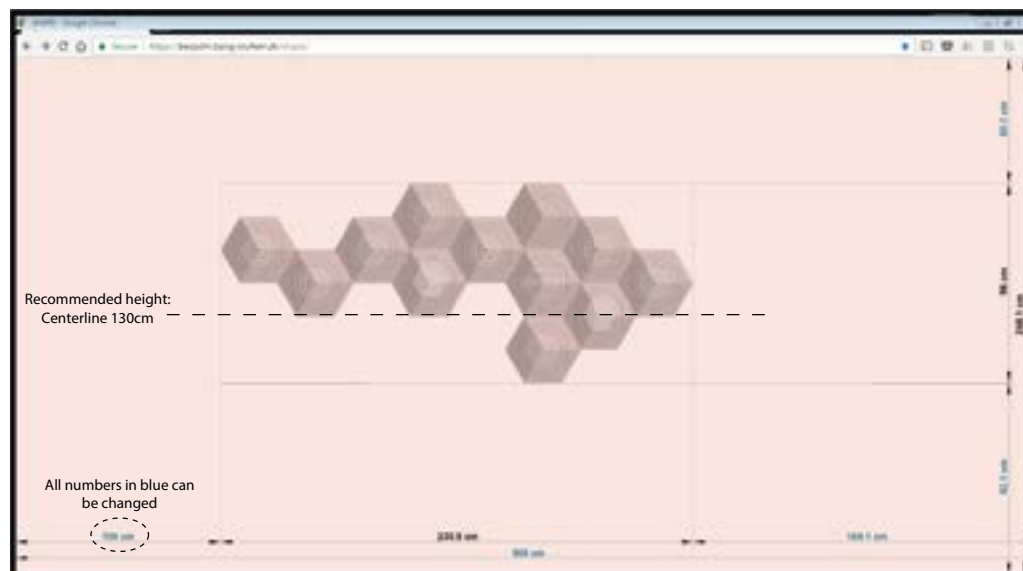

Note:

This tool is only an “add-on” to the Design Tool. The Placement Tool cannot generate the design ID and ordering list. The Design Tool can be found here: <https://www.bang-olufsen.com/en/collection/wireless-speaker-systems/beosound-shape/configurator>

Placement conditions

The product is intended for indoor use in dry domestic environments only. Use within a temperature range of 10-40°C (50-105°F).

Important! The BeoSound shape is only designed to be mounted vertically.

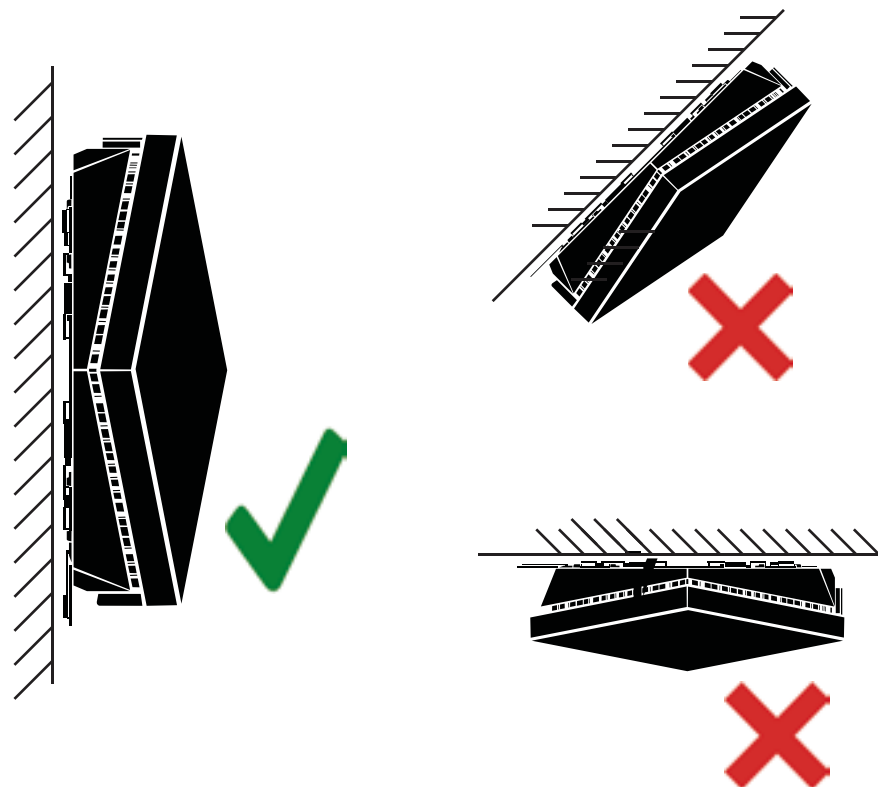

Mounting star rails

Be aware that the pattern of the final setup is not the same as the pattern only with star rails mounted on the wall. This is due to the different shapes of the star rails and the tiles with front covers (amplifier, speaker, damper and empty tiles)

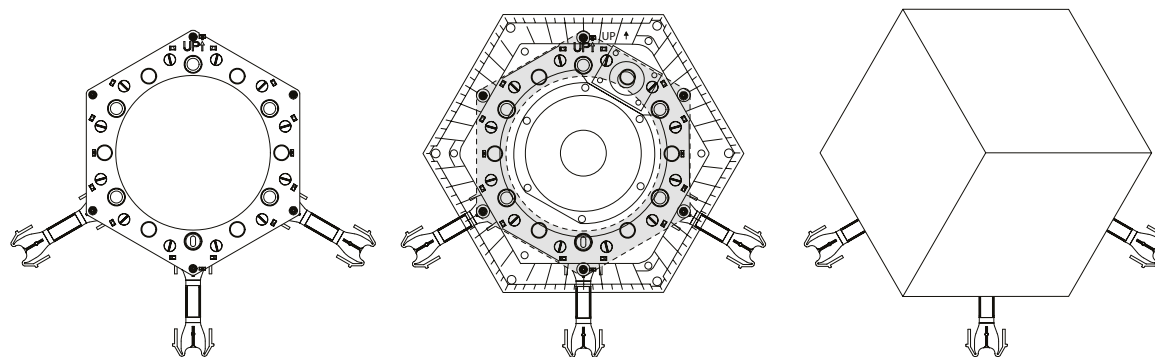

Lay all the star rails down on the floor in the chosen pattern according to the PDF document presented in the Configuration tool. Connect all the star rails with the connection rails.

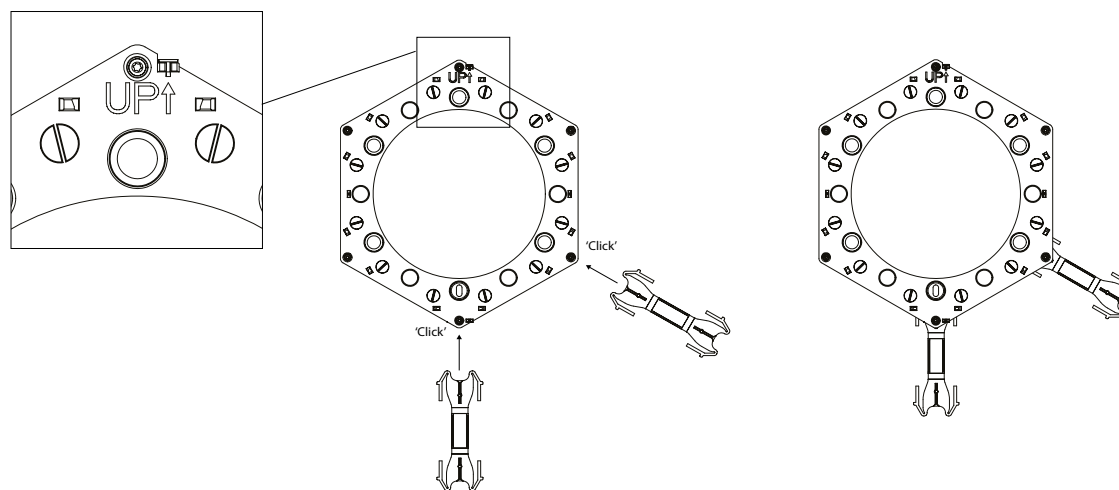

Example of star rail setup

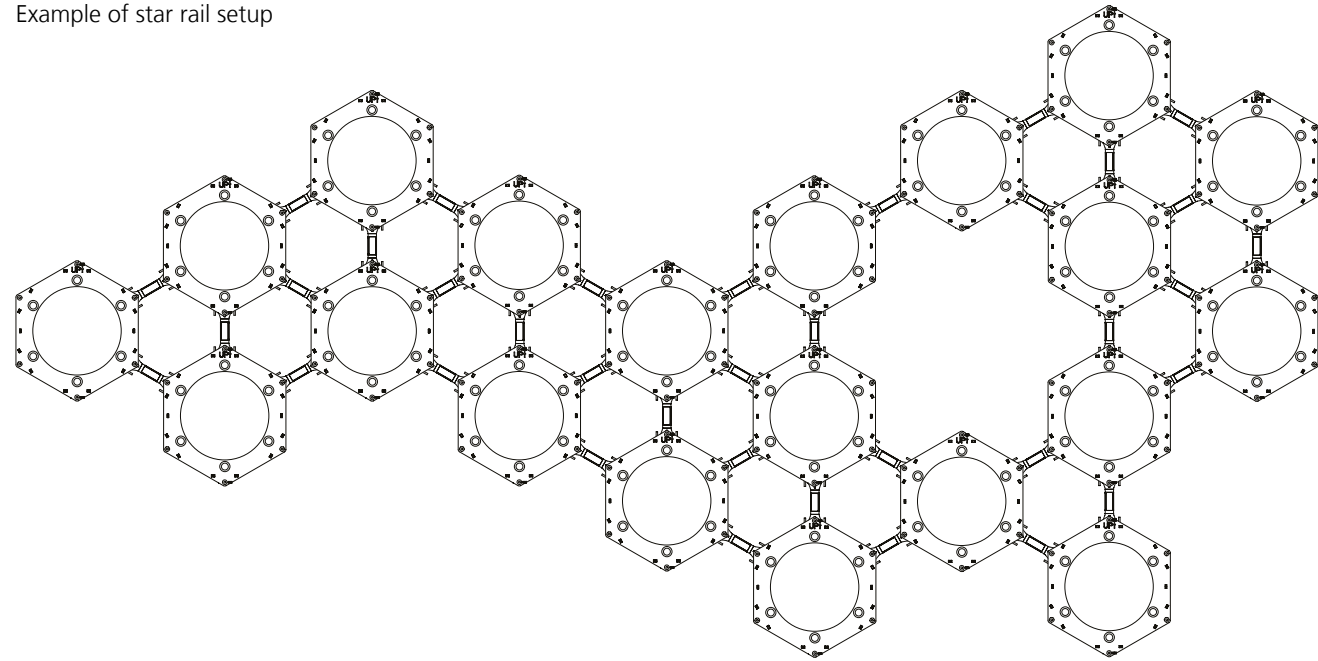

Disconnect the setup into smaller sections, e.g. 3-5 tiles depending on the setup. Start hanging up the most compact part of the setup.

Example: Start hanging up section 1, then 2 etc.

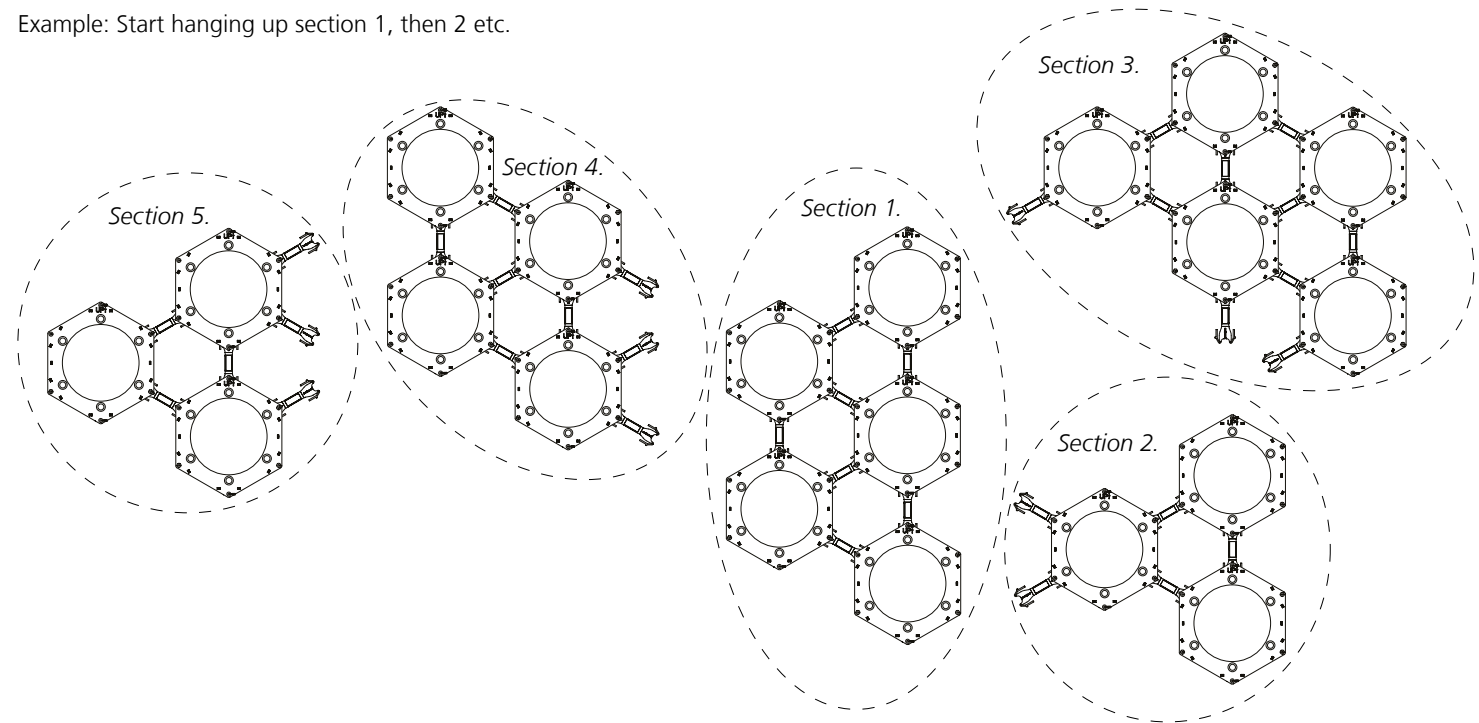

Placement of the wall socket

Before mounting the star rails, note the placement of the wall socket. Be sure to place the star rail for the empty tile over the wall socket. (A damper tile without the damping material can also be used for hiding the wall socket.)

Use the Placement Tool to calculate the placement of the star rail for the wall socket. <https://shapeinstaller.bang-olufsen.com/>

An extension cord with extra sockets can be hidden in the empty tile.

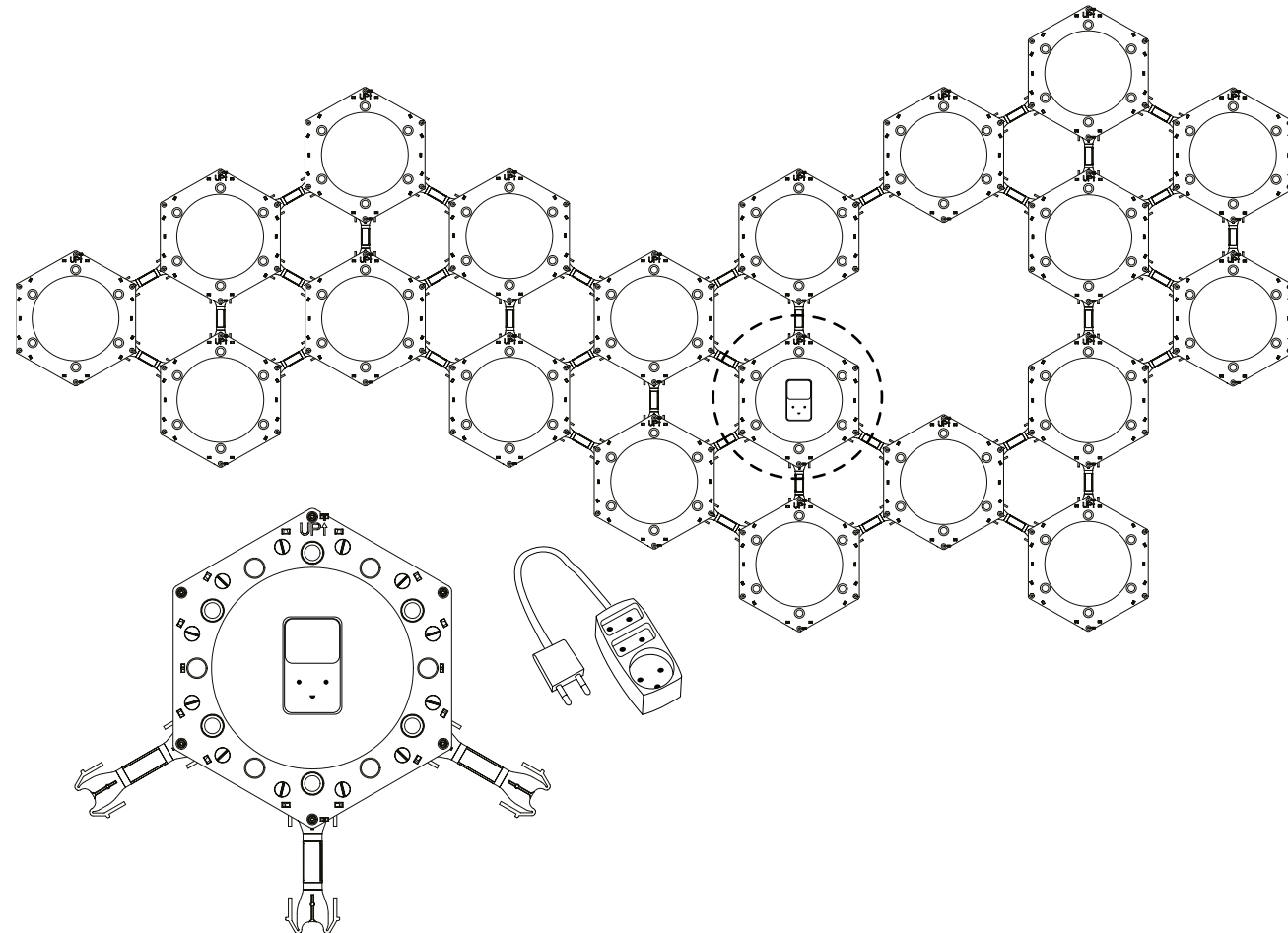

When mounting section 1, mount one screw and a washer in the top of one of the star rails. Use the Placement Tool to calculate the placement of the first screw. <https://shapeinstaller.bang-olufsen.com/>. Use a spirit level to level out the star rails, use the towers for levelling. Mount one screw and washer in the top of each star rail. Mount section 2, 3, 4 etc. (see page 11) Mounting one screw in the top of each star rail. Use a spirit level before mounting the screws. When all star rails are mounted with one screw, mount at least two more screws and washers in the star rail. Use at least three screws for each star rail in the setup. Use the spirit level on every star rail before mounting the screws. The enclosed felt stickers can be used on the star rails to outline points on the wall where the surface is uneven.. Note, screws for mounting on the wall are not included.

Recommended placement of screws

Alternative placement of screws

Incorrect placement of screws:

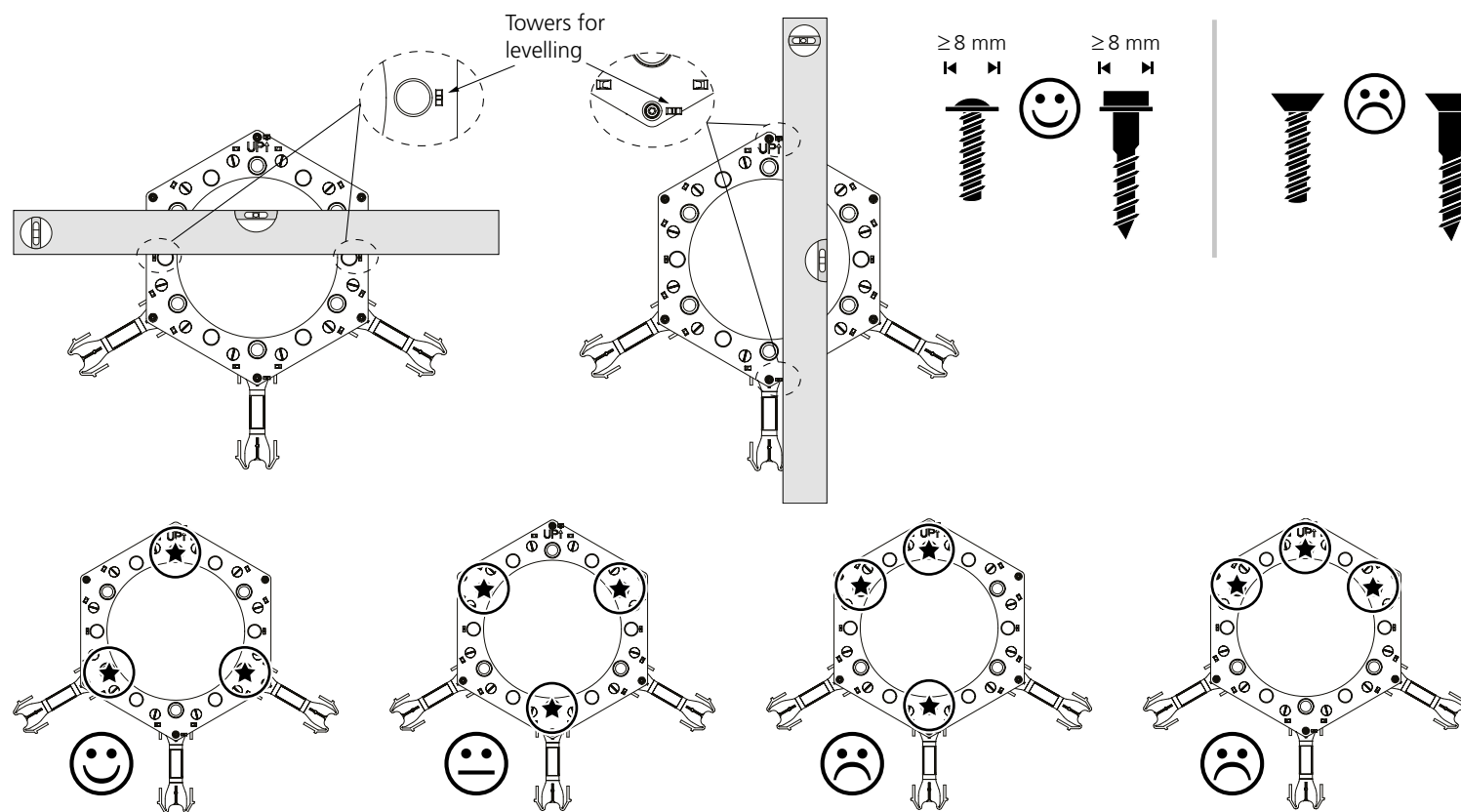

When more star rails are mounted, use a aluminium straight edge tool or a spirit level to level out the star rails crosswise and vertically.

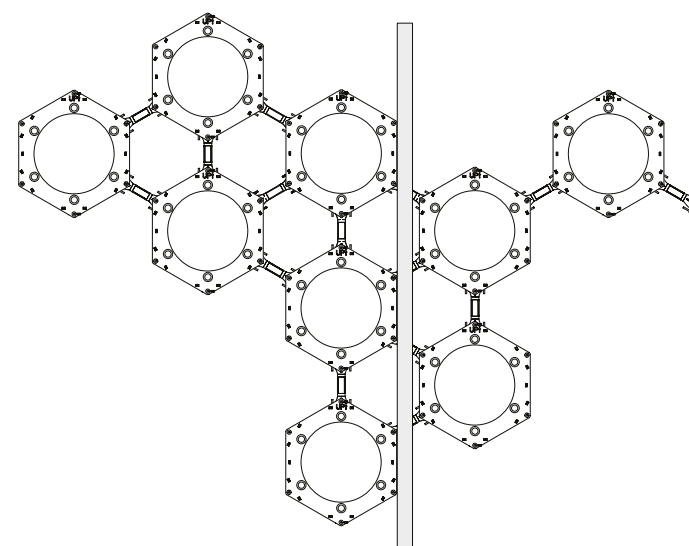
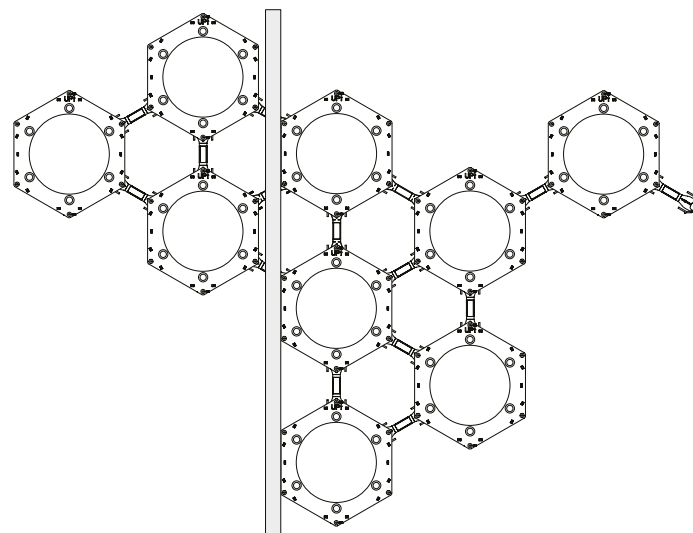
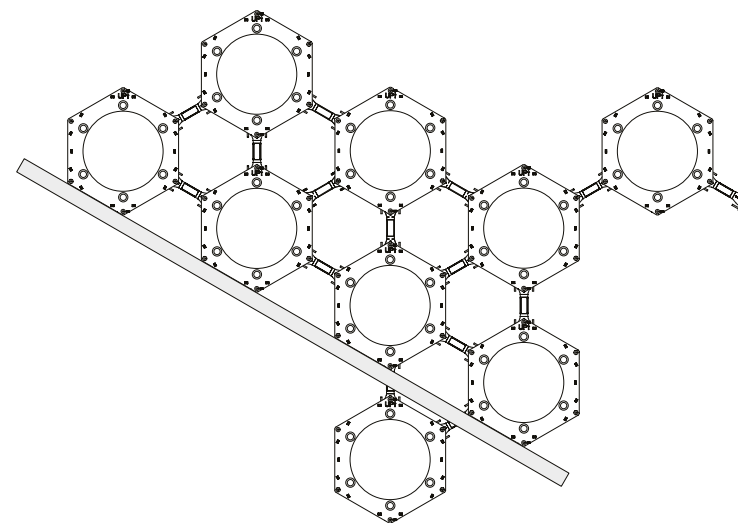
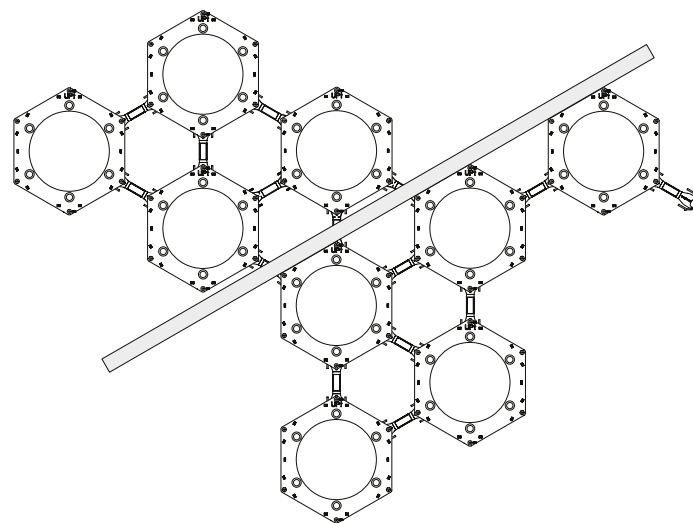

Extra supporting star rail

If the construction is unstable due to only one connection rail between two star rails, consider mounting some extra star rails and Connection Rails during the mounting.

Important

Mark the extra supporting star rail e.g. with tape over the mounting holes. Remember not to mount any screws in the extra supporting star rails and remember to remove the supporting star rails and the extra Connection Rails before mounting the tiles.

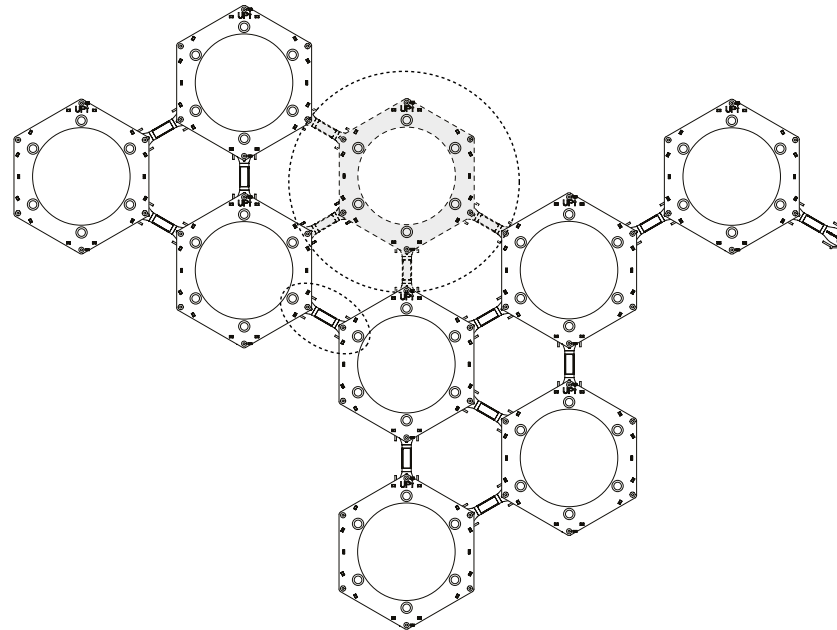

Mounting Bang & Olufsen logo badge

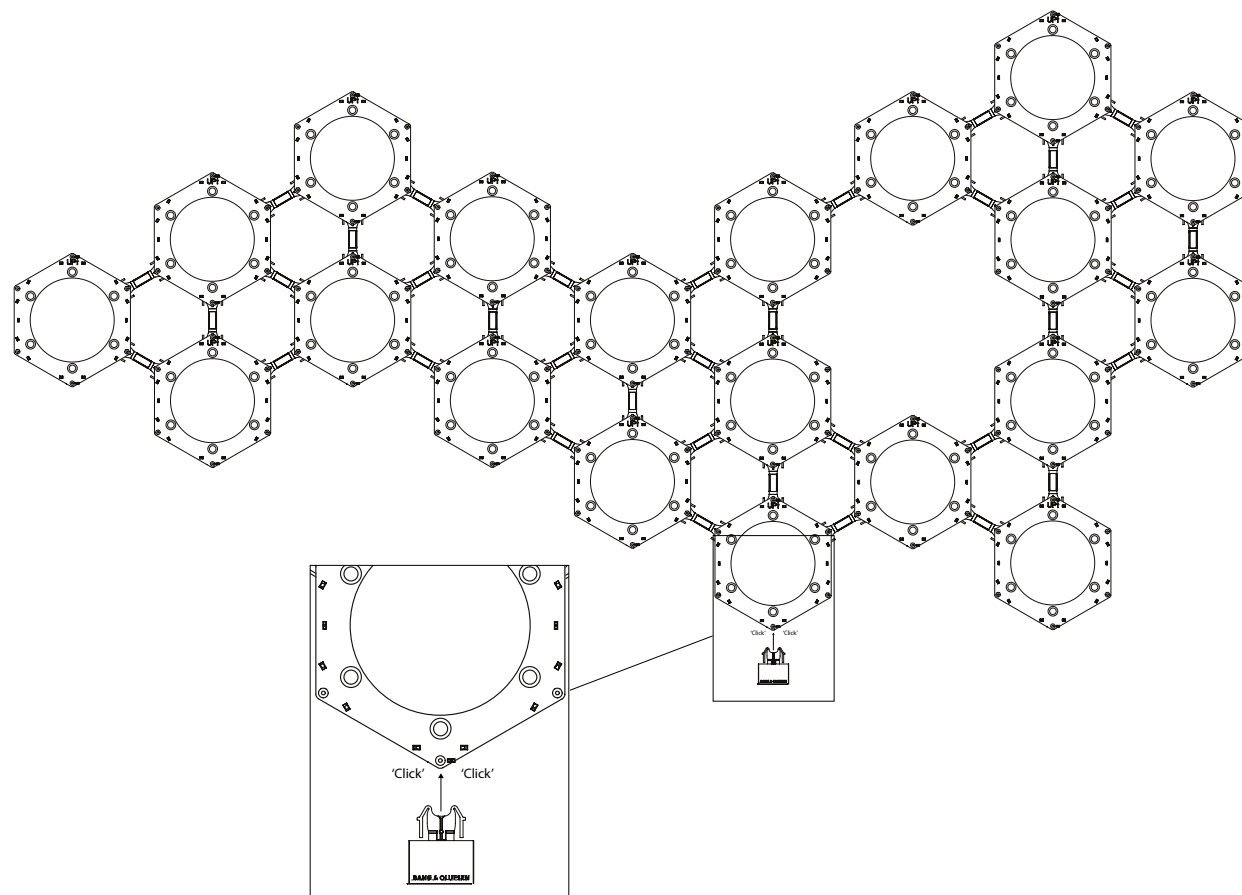

Mounting the tiles

Refer to the Installation Video 'How to mount your tiles' on <https://bang-olufsen.zendesk.com/hc/en-us/articles/360042003831>

Important!

The tiles must be placed in the exact positions as described in the PDF created in the Configuration Tool. Otherwise, the sound algorithm will not work properly, and you will not get the right 'Band on the Wall' effect. The placement-algorithm will always place amplifiers without a tile underneath, in order ensure sufficient airflow.

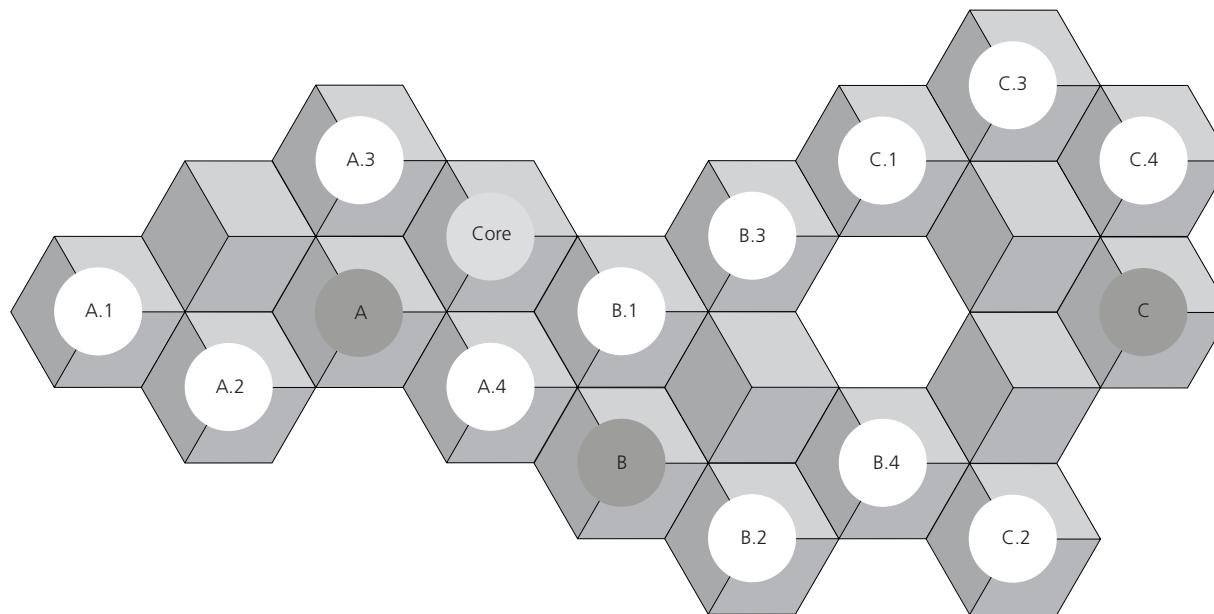

Core = Empty tile with BeoSound Core

A, B, C = Amplifier tiles

Note: A= Master amplifier (connected to the BeoSound Core) and B, C= Slave amplifiers.

A.1, A.2, A.3, A.4, B.1, B.2, B.3, B.4, C.1, C.2, C.3, C.4 = Speaker tiles.

Mounting the BeoSound Core

Refer to the Installation Video 'How to mount your BeoSound Core' on <https://bang-olufsen.zendesk.com/hc/en-us/articles/360042003831>

Connecting cables

Refer to the Installation Video 'How to connect the cabling' on <https://bang-olufsen.zendesk.com/hc/en-us/articles/360042003831>

Attention! Do not bend the optical cable.
The minimum bend radius for the optical cable is two centimetres.

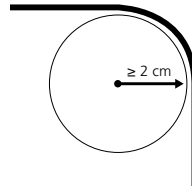

Remember to remove plastic protection cover from optical cable.

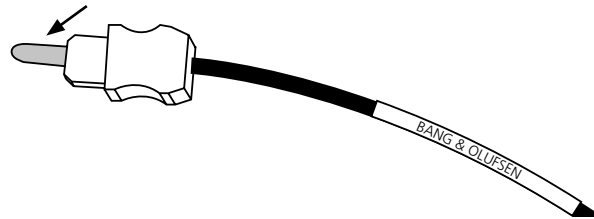

Maximum length of Ethernet cable:
Between each amplifiers, maximum 15 metres.
Total length, maximum 40 metres.

Maximum length of speaker cable:
Between amplifier and speaker, maximum 5 metres.

Cabling between the tiles

Guide the cables between the tiles, though the cable guides. The cable guides are placed on each sides of the tile, over the connector rails. Cover the cables and the gap between the tiles with the gap absorber.

Note! Only one or two layers of cables in the cable guides between the tiles. If more the fabric cover can be misplaced.

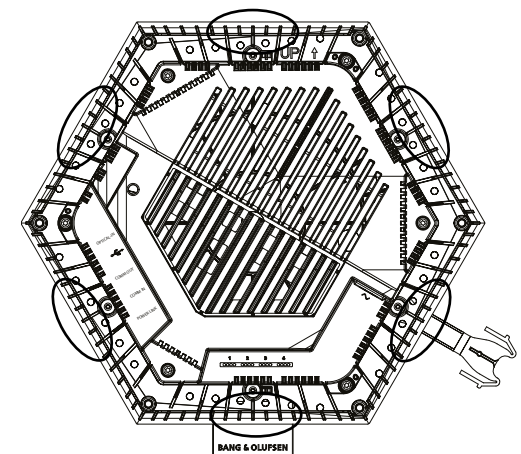

Mounting the signal cables

Connect speaker cables from amplifier A connection 1 to speaker A1, connection 2 to A2, connection 3 to A3 and connection 4 to A4. And from amplifier B to B1, B2, B3 and B4 etc.

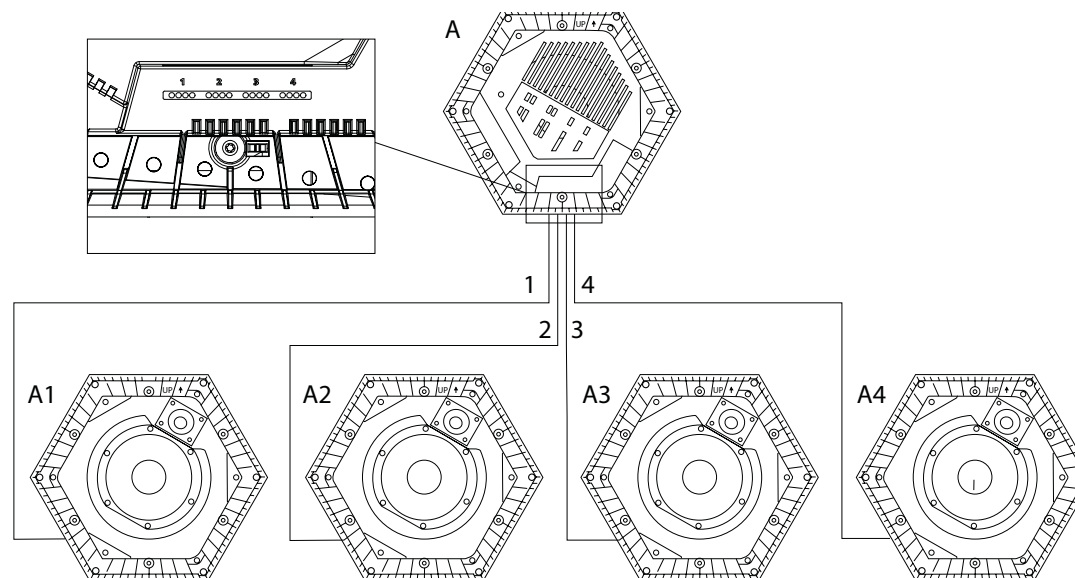

How to shorten the signal cables for the speakers

It can be tricky to mount the plugs on the speaker wire. To make it easier, we suggest mounting the plug on a speaker tile before mounting the four cables into the plug. Then the plug is positioned and easier to work with.

Use a small screwdriver with one hand to open up the first socket in the plug. Place the first cable into the open socket and let go of the screwdriver to lock the cable in the socket. Follow the same procedure on the next three sockets. Remember to follow the colour combination shown on the product

Refer to the video on: <https://youtu.be/EFNFVEwQ6cU>

Multiple amplifier setup

For setups with more than one amplifier, the amplifiers must be bridged together with a RJ45 cable (minimum CAT5 cable). E.g.: Amplifier A - COMM OUT has to be connected to amplifier B - COMM IN. Amplifier B - COMM OUT has to be connected to Amplifier C - COMM IN etc.

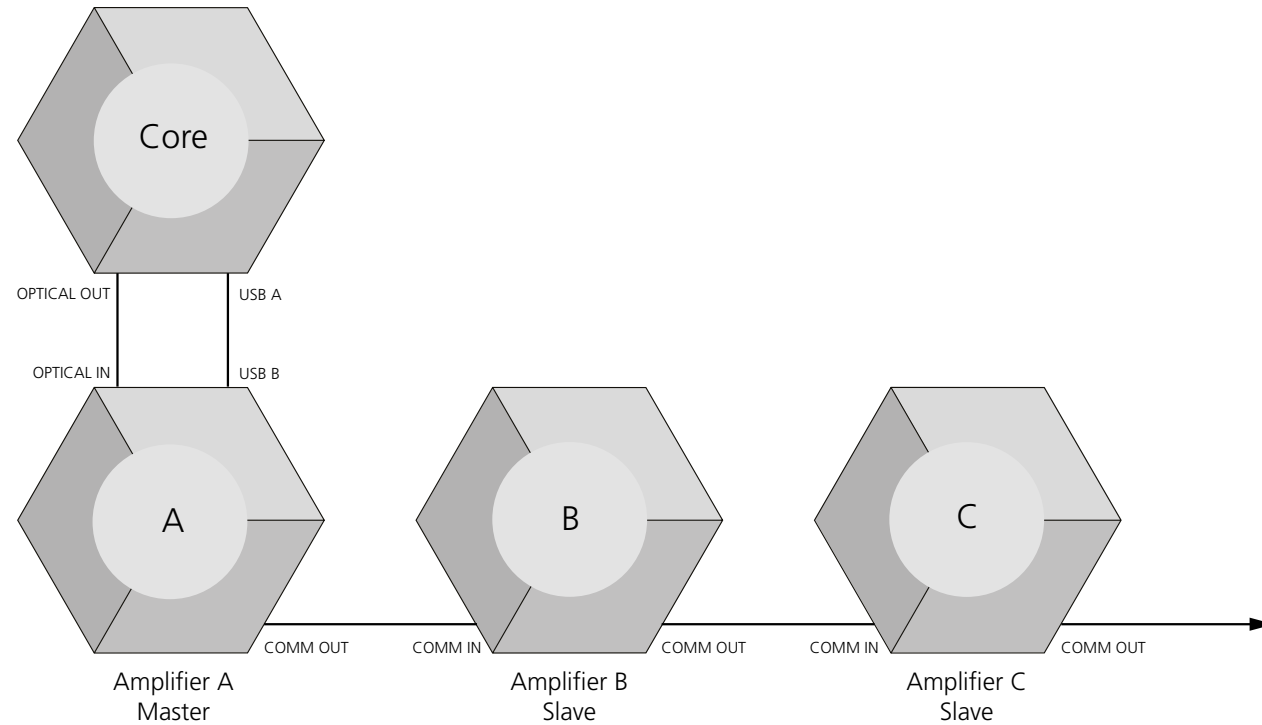

Amplifier tiles are delivered as 'slaves' from factory. The amplifier 'A' will automatically change to 'Master' during first time set up. A master amplifier tile will turn white for approx. 3 seconds during start-up, and a slave amplifier tile will turn magenta for approx. 3 seconds.

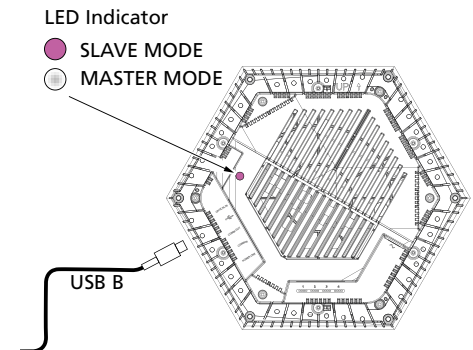

First-time setup

For first-time setup, refer to the Installation Video ' How to configure your BeoSound shape using Bang & Olufsen app' on <https://bang-olufsen.zendesk.com/hc/en-us/articles/360042003831>.

First-time connection

First time you connect a BeoSound Core to a BeoSound Shape setup, it will in some cases appear in the Bang & Olufsen app as a BeoSound Core. In order to change it to a BeoSound Shape, you must connect to the amplifier via USB and reset the BeoSound Core.

Follow these steps:

- Connect USB and Optical cables to the BeoSound Core and the amplifier tiles
- Connect power to BeoSound Core and amplifier tiles
- Factory-reset the BeoSound Core by holding the Reset button for 10 seconds, or alternatively, using the Bang & Olufsen app
- The BeoSound Core will then appear as BeoSound Shape

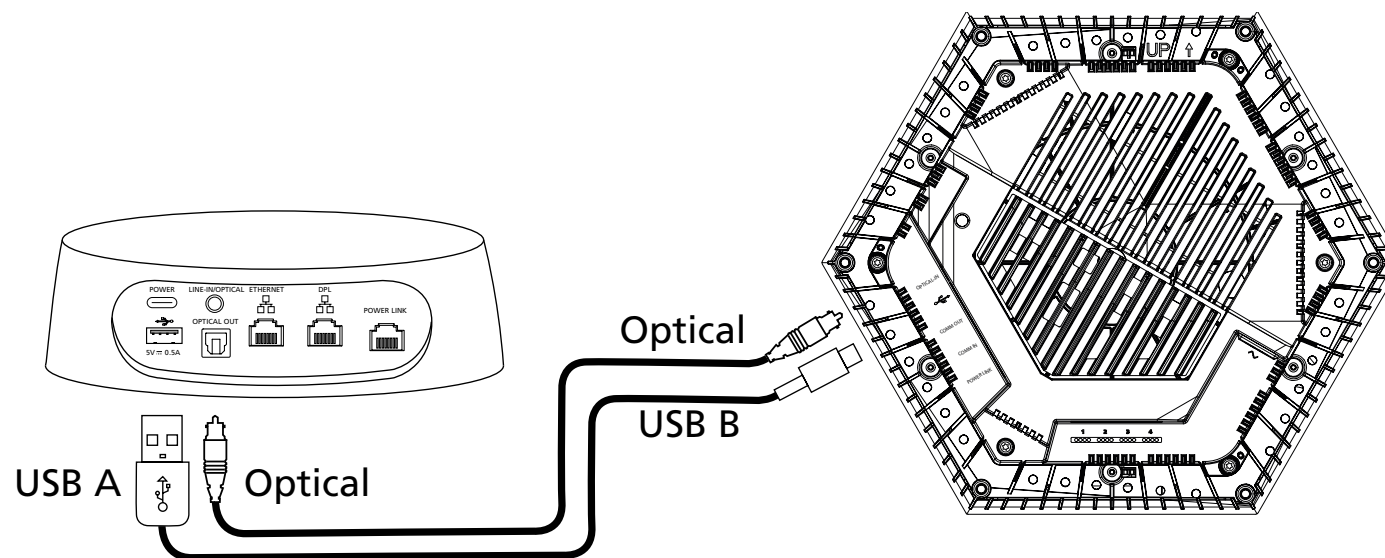

Mount fabric cover

Place the fabric cover on the cabinet and press gently to attach the fabric covers.

Note the fabric pattern, must be identical on all tiles. It is recommended to place front covers with Kvadrat fabric with the texture as shown on the drawing below. Recommended placement for front covers with Define fabric, see next page.

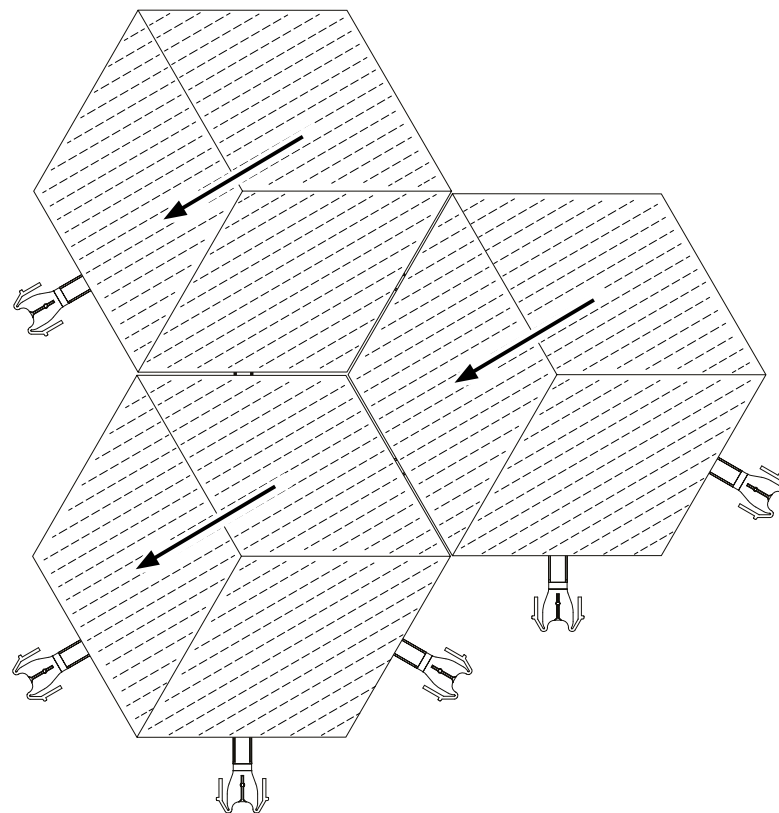

Place front covers with Define fabric with the texture as shown on the drawing below.

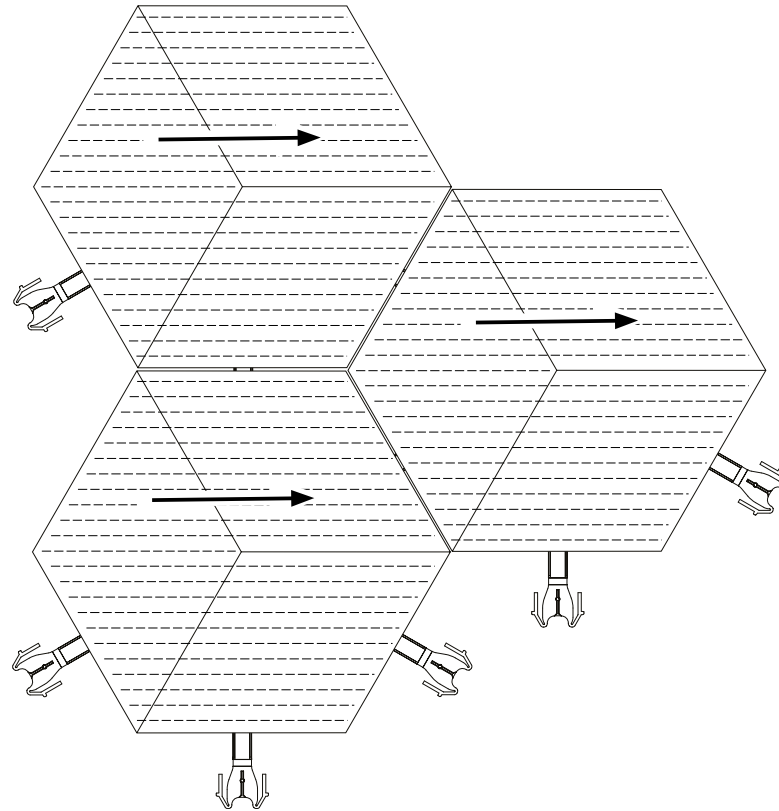

Mount wood cover

Place the wood cover on the cabinet and press gently to attach the wood covers.
Important! Wood covers must only be used together with damper tiles

Note the gains pattern, must be identical on all tiles. It is recommended to place front covers with wood with the gains as shown on the drawing below.

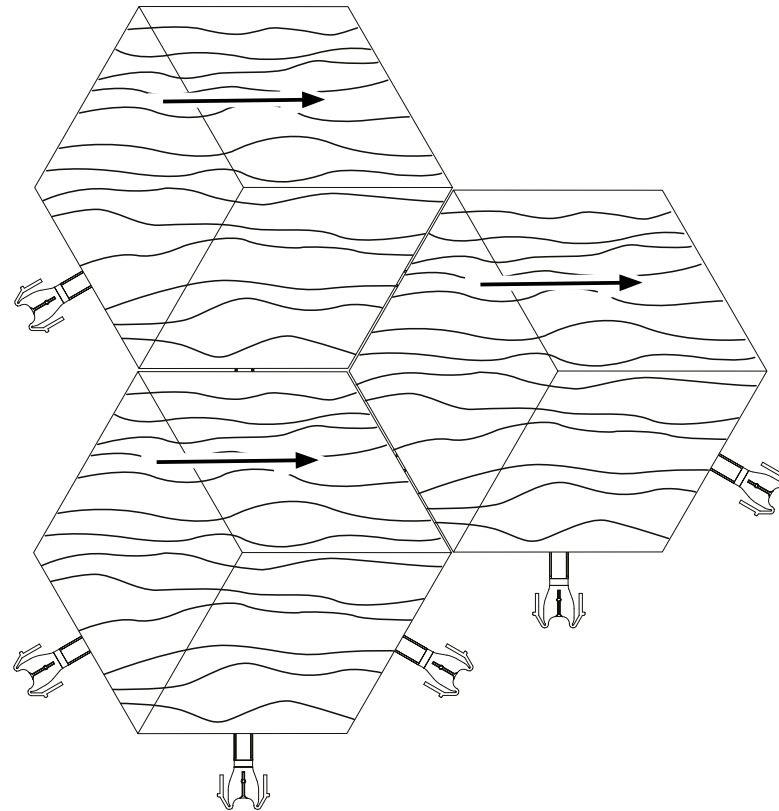

How to upgrade an existing BeoSound Shape with more tiles

It is possible to upgrade an existing BeoSound Shape setup with more tiles. When doing this, it is needed to create a new design ID via the online Configuration tool. Please follow the setup instructions in the PDF file from the online Configuration tool. It can be necessary to reorder some of the old tiles in the existing setup. It is needed to factory reset the BeoSound Core and remove the BeoSound Shape in the Bang & Olufsen app, before starting to add or reordering the tiles. When the new setup is mounted, you will have to reconfigure the new BeoSound Shape with the new design ID via the Bang & Olufsen app.

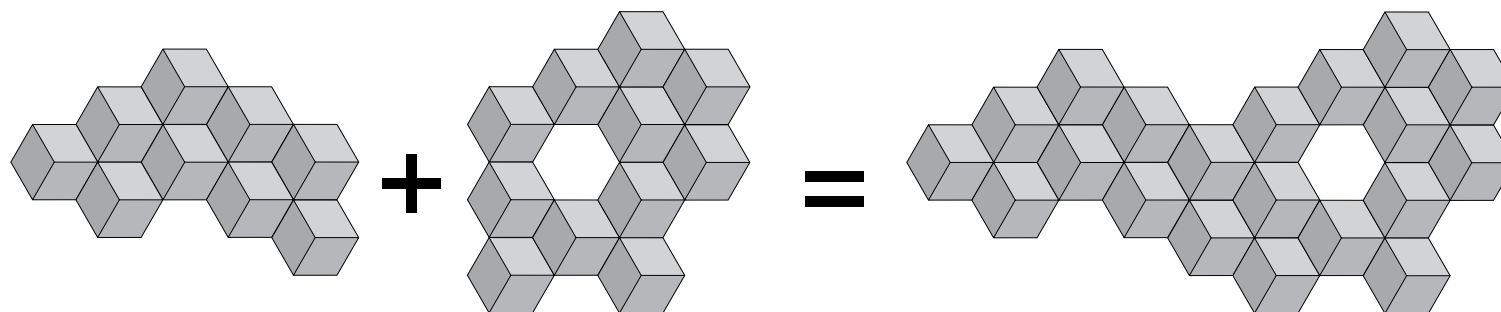

Alternative setup

‘Band on the wall’ without BeoSound Core

It is possible to use the BeoSound Shape without a BeoSound Core. But you will still need to load the filter settings using a BeoSound Core. Be aware that amplifiers cannot get firmware update without connection to a BeoSound Core.

If you want to use BeoSound Shape and ‘Band on the wall’ without a BeoSound Core, but with a Moment instead, you have to connect a BeoSound Core to the setup to load the Design ID.

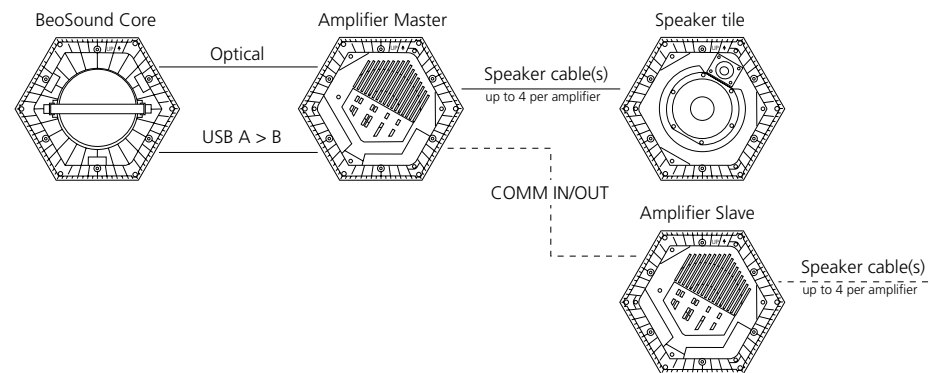

When the filters are applied, and all speakers are tested, you can now disconnect the USB and Optical cable, and replace them with a Power Link cable from the BeoSound Moment instead. If the BeoSound Shape is not mentioned in the speaker menu, use BeoLab 17.

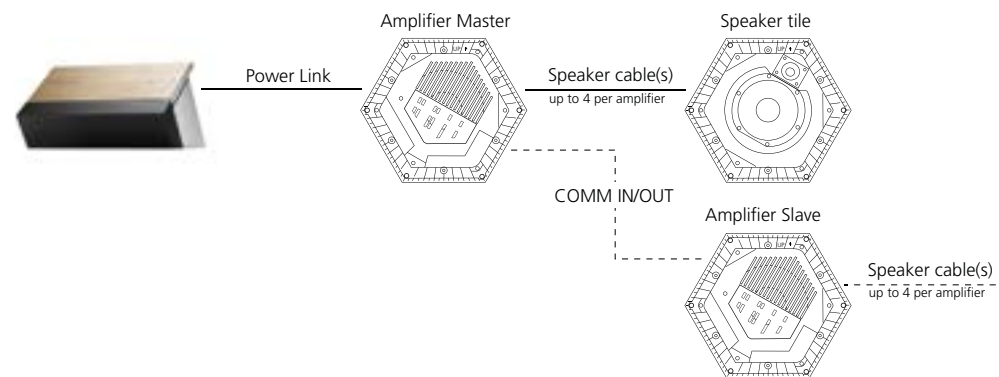

BeoSound Shape with BeoLab 19

BeoSound Shape can be connected to a subwoofer. It has to be a BeoLab 19 due to the adjustment possibility on the BeoLab 19.

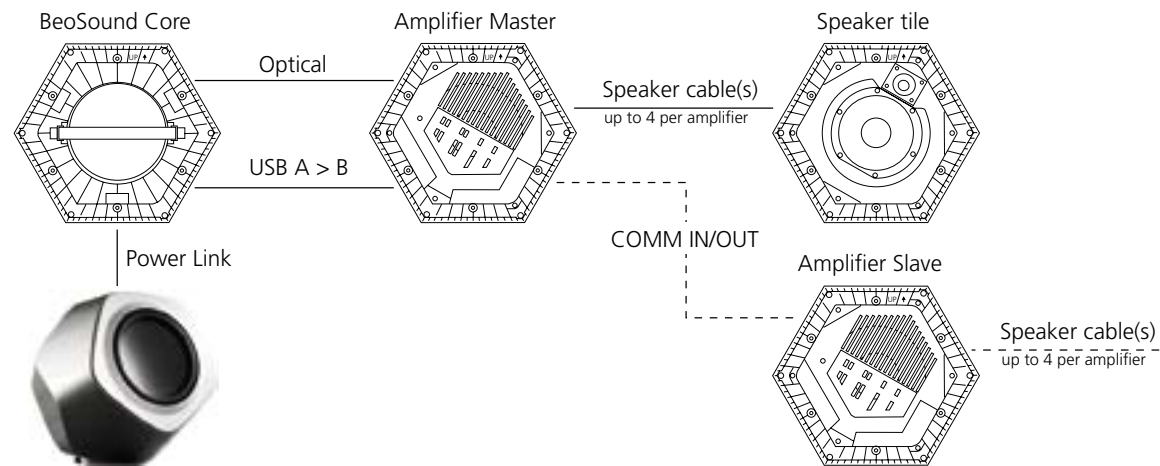

Gain adjustment on BeoLab 19 must be adjusted depending on the number of speakers connected in the setup. Adjust until the bass level is as desired.

Starting points:

- 4 speaker tiles: 4 o'clock
- 8 speaker tiles: 2 o'clock
- 12 speaker tiles: 12 o'clock (Gain = 0)

For adjustment of 'Bass Tone Control' see next page



GAIN 2 o'clock
 LP filter ON 120Hz
 PHASE POS 0
 WIRED L+R

Bass Tone Control must be adjusted via the Bang & Olufsen app. Choose 'My Products' and select 'BeoSound Shape'. Choose 'Configure' -> Sound -> Sound controls and adjust 'Bass Tone Control' between -6 and -10 depending on the numbers of speakers in the setup.

- 4 speakers: Set bass to -10
- 8 speakers: Set bass to -8
- 12 speakers: Set bass to -6

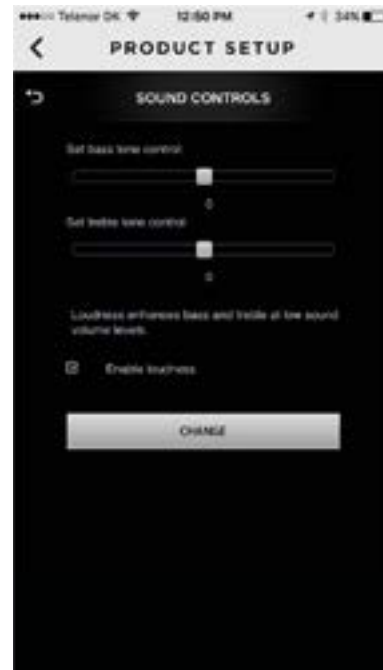

Stereo setup - Left & Right

Initial setup

The BeoSound Shape can be used in a normal stereo setup. The setup will **not** have 'Band on the Wall' effect. This can e.g. be useful when the BeoSound Shape is used as rear speakers. In the following stereo setup, no Design ID is used; instead the standard filter is used. Daisy chaining to other amplifiers is not possible when using standard filters.

Note! The amplifier must always be placed without a tile underneath.

Amplifier tiles are delivered as 'slaves' from factory. The amplifier must be set as 'Master' if it is used in a stereo setup. To set up the amplifier, a BeoSound Core must be connected.

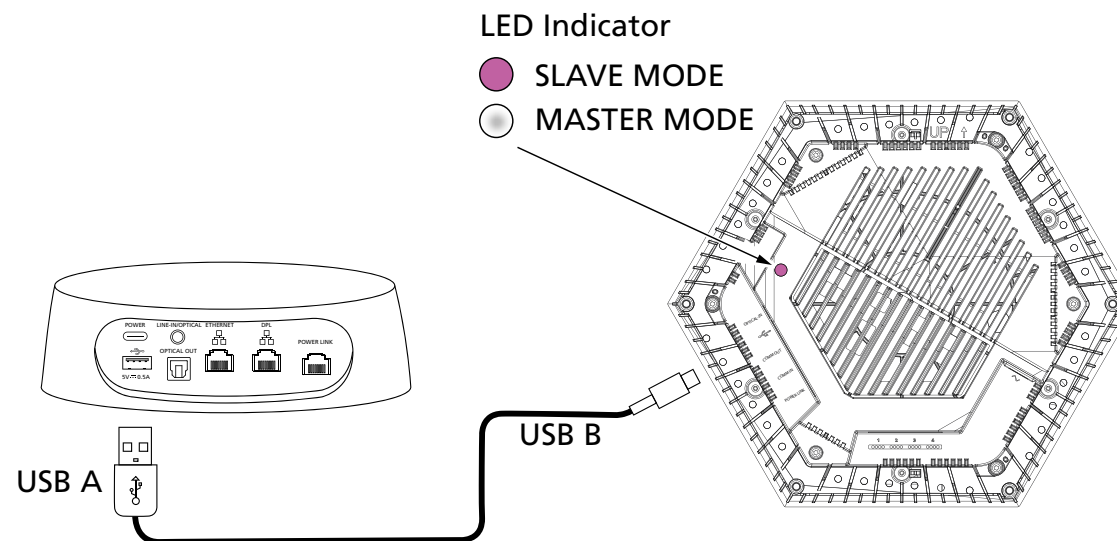

To load the standard filter into the amplifier tile, the tile has to be converted to master mode. Follow these steps:

- Connect the amplifier tile to a factory reset BeoSound Core.
- Connect the BeoSound Core to the amplifier tile by using the USB connection.
- Power up both units.
- When the BeoSound Core is booting up, it will update the amplifier tile to be in the master mode and load in the standard sound filter.
- After the update is done, the amplifier tile will shortly light up in white colour which indicates master mode. Do not remove the BeoSound Core before this light is seen.
- If no white light is seen within 5 minutes, make a factory reset of the BeoSound Core to restart the process.

After the amplifier tile has been updated to Master mode and the standard sound filter has been loaded, the output channels will look like this:

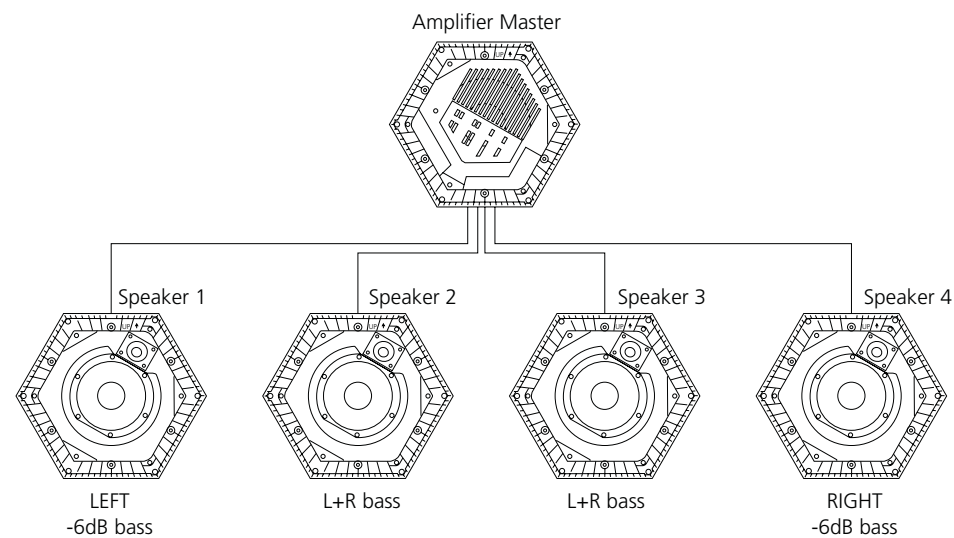

Note!

Bang & Olufsen televisions use Bass Management. If using big speakers (BeoLab 5, BeoLab 9, BeoLab 20 BeoLab 50, BeoLab 90) or subwoofers, (BeoLab 2, BeoLab 19, BeoLab 14 Sub), you might experience no sound in speaker 2 and 3. For more information about Bass Management, see 'Technical Sound Guide' on BeoWise.

Stereo setup - Left & Right
Wired stereo setup

In this setup the amplifier must be setup as a master. The TV is connected with a Power Link cable.
If BeoSound Shape is not in the speaker menu on the TV - Use BeoLab 17.

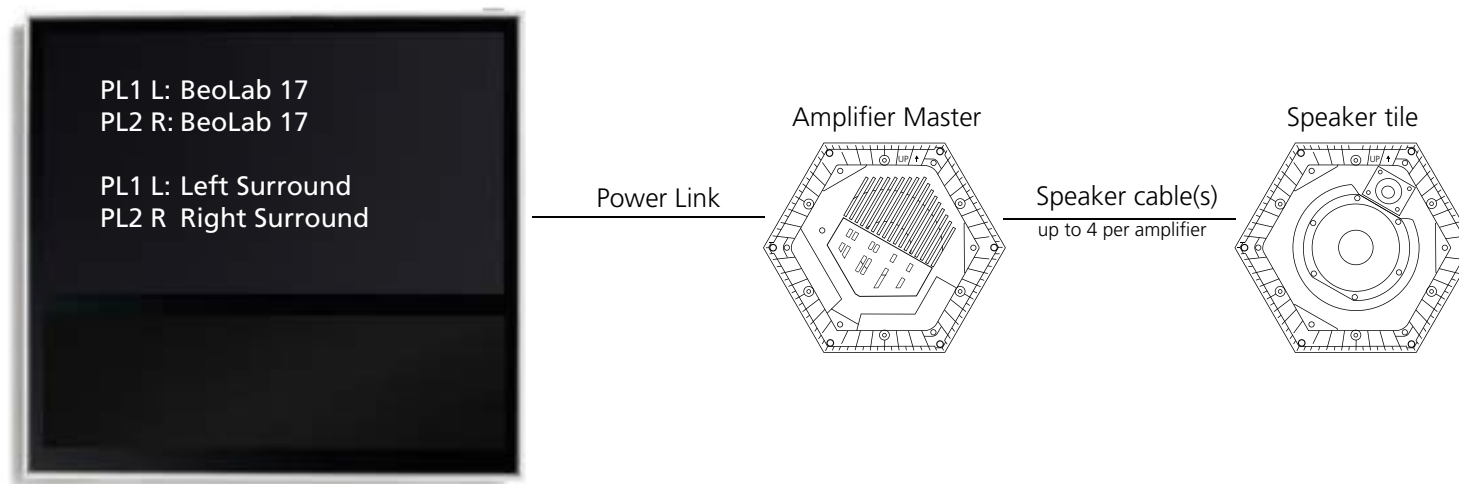

Note: In this example the BeoSound Shape is used as rear speakers in a TV setup.

Stereo setup - Left & Right

Divided setup with 1 amp / 4 speakers

The BeoSound Shape can be used as front speakers, either by having 1 amplifier and 4 speakers or by 2 separate setups, with 1 amplifier and 4 speakers in each side. For setup with 2 amplifiers See [page 33](#).



Note!

We recommend no more than 5 metres of speaker cable per channel. .

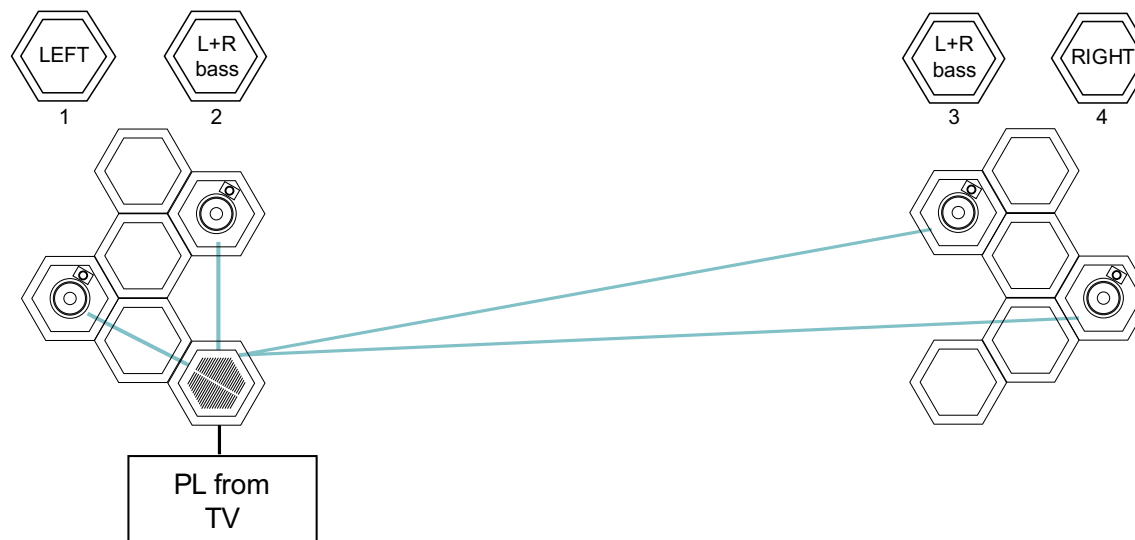

Stereo setup - Left & Right

Divided setup with 2 amps / 8 speakers

Another way is to have 2 separate setups, with 4 speakers on each side. This way you can also benefit from the true image technology in our tv's, and get a wider sound experience.

Remember that each amplifier needs to be programmed as master.

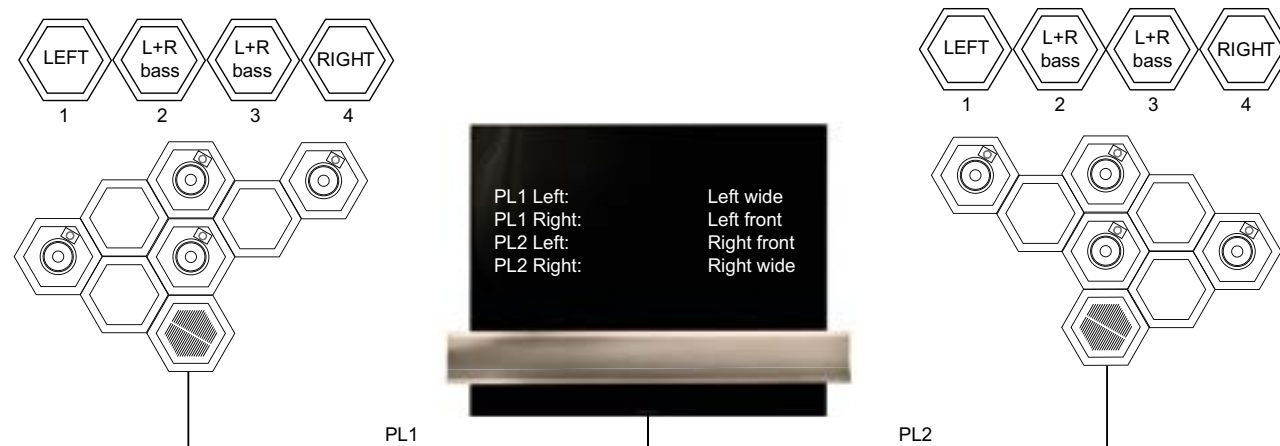

Software update

How to see the software version

Software can be checked and updated via the Bang & Olufsen app.

The BeoSound Core software version can be seen by following these steps:

1. Open the Bang & Olufsen app
2. Go to Settings (press the cogwheel symbol)
3. Select the **My products** menu
4. Select your **BeoSound Shape**
5. Select the **About product** menu

The amplifier tile software version can be seen by following these steps:

1. Open the Bang & Olufsen app
 2. Go to settings (press on the cogwheel symbol)
 3. Select the **My products** menu
 4. Select your **BeoSound Shape**
 5. Select the **Configure** menu to enter the product configuration
 6. Select **SOUND**
 7. Select **SHAPE INFO**
 8. Look for **App: X.X.X.X**
-

Automatic software update

Is per default (factory reset) set to On and can be set to Off (not recommended).

If set to On and BeoSound Shape is in standby mode, a check for new updates are made every night (local time) somewhere between T00:00 and T06:00.

During software update the BeoSound Core will be updated first. The LED on the Core will flash red. When the Core has been updated, the amplifiers will, in a setup with 3 amplifiers, be updated in the following sequence :

- First the master amplifier A (the amplifier connected to the BeoSound Core) will flash red for a few seconds, and then it will become solid white, for a couple of seconds. Then the light will turn off.
- Then the slave amplifier C will flash red for a few seconds, and then it will become solid magenta, for a couple of seconds. Then the light will turn off.
- Finally, the slave amplifier B will flash red for a few seconds, and then it will become solid magenta, for a couple of seconds. Then the light will turn off.

(Note: White colour means that the amplifier is the master amplifier, i.e. connected to the BeoSound Core. Magenta colour means that the amplifier is configured as a slave amplifier)

In the following setups, it may be relevant to set automatic update to Off: Hotels, stores, home automation and test environments, as if an update takes place either in BeoSound Shape or in another Network Link product, all other Network Link products will then ask if they should also be updated. This may be unlikely in certain situations. If automatic SW update is set to Off, then check for updates regularly, when ready to take updates.

Web interface access to the BeoSound Shape



You can get access to the web interface via the Bang & Olufsen app or by using a computer.

Using a computer the BeoSound Shape must be connected by a LAN cable to the home router/AP and the computer must likewise be connected to the home router/AP either by a LAN cable or wirelessly. Handheld devices with a web browser may also be used and connected to the home router/AP.

The handheld device/computer gets access to the web server using a web-browser (Google Chrome or Safari) and in the address field entering: `http://< BeoSound Shape IP address>`, where

- `<BeoSound Shape IP address>` = the address assigned by the home router.

The `<BeoSound Shape IP address>` can be found using a freeware program, either "Discover digital networks" or "Fing".

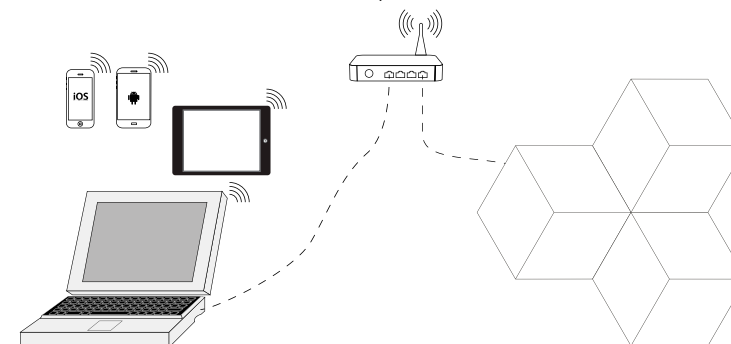

Troubleshooting

- Check all connection between the tiles.
- Check for newest software release on both the BeoSound Core and the amplifiers. If old software, update the products. The software can be updated via Bang & Olufsen app. See [page 34](#)
- Check if the correct Design ID is in the product, can be read out via the Bang & Olufsen app.
- If Design ID cannot be loaded during first-time setup, check that only one amplifier tiles is master. The Master amplifier tile flash/turns white, and the Slave amplifier tile flash/turns magenta. If more than one amplifier tile flashes white, change the amplifier to slave. See [page 38](#) - How to reset the BeoSound Shape amplifier tile.

How to reinstall the setup

- Reset BeoSound Core
- Delete the BeoSound Shape in the Bang & Olufsen app. It is now possible to run the first-time setup again via the Bang & Olufsen app.

Power cycle - Amplifier

If the system has not been playing music for more than 20 minutes, the amplifier enters standby.

If mains is removed and applied again within 60 seconds while the amplifier is in standby, the amplifier might appear 'dead' (no light). Solution is to disconnect from mains for more than 60 seconds

How to factory reset the BeoSound Shape amplifier tile

In some cases it can be necessary to factory reset the amplifier tile. For instance, if the amplifier tile is in Master mode and it should be reconfigured to the default Slave mode. Remember that in a complete setup, only one amplifier tile can have the Master role.

A factory reset of the amplifier tile can be done in the following way:

1. Connect the amplifier tile to a BeoSound Core via the USB connection.
 2. Power up both units and let the BeoSound Core boot up.
The BeoSound Core does not need to be connected to the network.
The BeoSound Core has finished booting when the LED turns solid white (connected to network) or is flashing orange (not connected to the network).
 3. After the BeoSound Core has booted, make a reset by inserting e.g. a straightened paper clip in the pinhole on the back of the product.
Note: This will factory reset the BeoSound Core and the connected amplifier tile.
 4. Some seconds after the reset, the amplifier tile LED will turn magenta for 3 seconds.
 5. When the magenta colour is seen on the amplifier tile, quickly pull out the USB cable.
- If the USB cable is not pulled out, the amplifier tile will again convert to Master mode, when the BeoSound Core boots up.

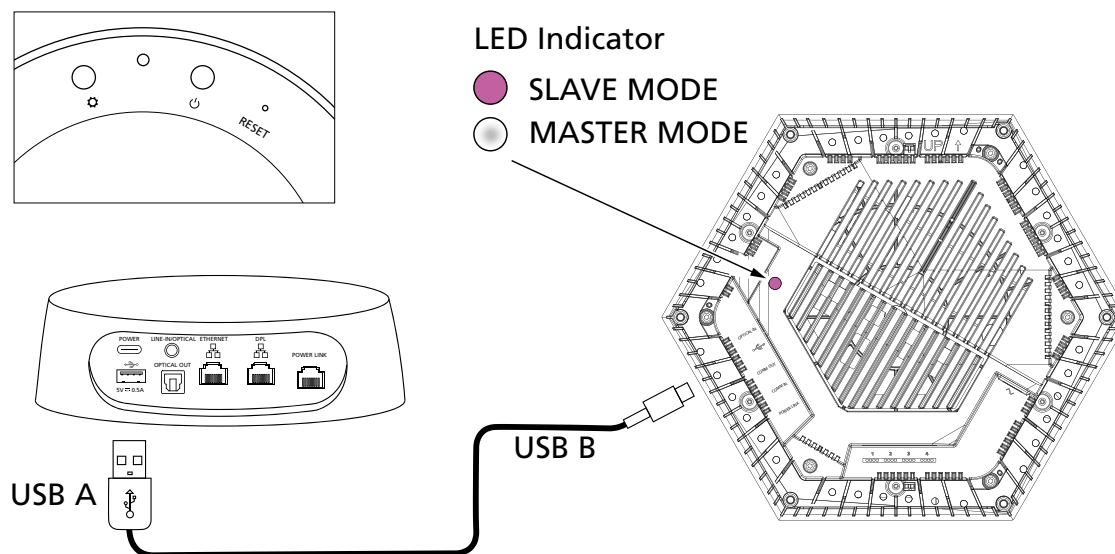

LED indications

Description	LED Indicator on the amplifier	
	Master	Slave
Starting up	Pulsing white	Pulsing magenta
Product On	Solid white for 3 seconds then off	Solid magenta for 3 seconds then off
Product warning 1*	Pulsing yellow	Pulsing yellow
Product warning 2*	Flashing yellow	Flashing yellow
Product error*	Flashing red	Flashing red
Product entering standby	Pulsing red for 3 seconds then off	Pulsing red for 3 seconds then off
Product in standby	Off	Off
During software update	Pulsing red	Pulsing red

* An overheating problem has occur.

Product behaviour:

Product warning 1 The amplifier will reduce gain. (Turning down the volume).

Product warning 2 The sound from the amplifier will be muted.

Product error The amplifier will turn off.

Technical specifications

Designer:

Øivind Alexander Slaatto

Maximum number of amplifier tiles: 11

Maximum number of speaker tiles: 44

Maximum number of Acoustic damper tiles: unlimited

Materials:

Lightweight composite casing and fabric covers.

Dimensions:

Tile with fabric and star rail system: 36.4 x 32.0 x 11.1 cm

The star rail system makes a 0.6 cm air gap between cabinet and wall.

The size of the gap between the fabric covers depends of the type of the fabric.

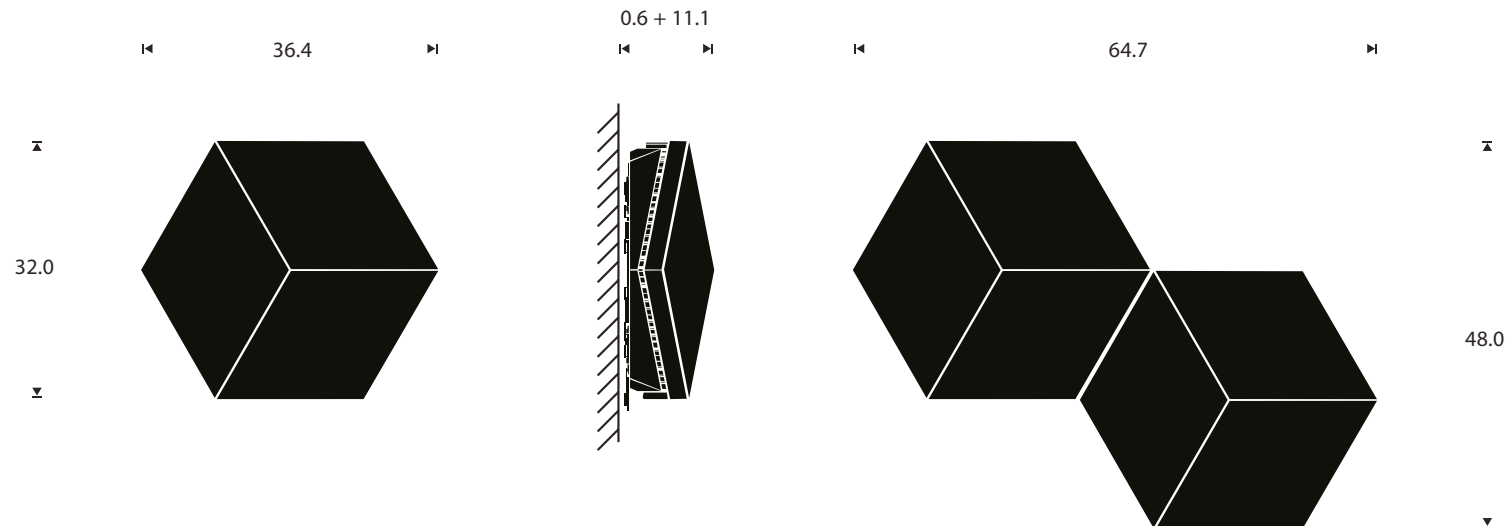

Amplifier tile

Weight: 2.0 kg + 0.4 kg (fabric cover)

Power amplifiers: 8 x 80 Watt (Class D)

Maximum speakers per amplifier: 4

Cabinet colour: Black

Connections:

- AC power (note if multiple amplifier, each requires its own AC power connection)
- Optical In - Digital audio input
- USB (for control and SW update)
- Power Link input
- COMM IN - Amplifier input (sound & control input), for daisy chaining of amplifiers
- COMM OUT - Amplifier output (sound & control output), for daisy chaining of amplifiers
- 4 x speaker 4-wire output

Speaker tile

Weight: 1.9 kg + 0.4 kg (fabric cover)

Cabinet principle: Closed box

Cabinet colour: Black

Speaker drivers:

- Woofer 5¼"
- Tweeter ¾"

Connections:

- 1 x speaker 4-wire input

Damper tile

Weight: 0.51 kg + 0.4 kg (fabric cover)

Cabinet colour: Black

Damper tiles can be used also as empty tiles to hide, for example, cables, power strips, or power adapters. You just need to remove the sound absorbing material.

Covers

Each tile requires a cover.

Available colours: Black, Brazilian Clay, Infantry green, Parisian Night blue, Purple Heart, Wild Dove grey

Kvadrat fabric: Brown moss green, pink, dark blue

Define fabric: Grey, dark grey

Wood cover: Dark oak (important! Wood covers must only be used together with damper tiles)

Connectivity (provided by BeoSound Core)

The BeoSound Core (which connects to the optical-in and the USB of the BeoSound Shape) provides the wireless streaming connectivity to the BeoSound Shape. BeoSound Core fits into an empty tile and is thus invisible.

Dimensions and weight: '

Base diameter 151.20 mm Height 43.5 mm – 290 grams
USB-C power supply weight: 150 grams

Wireless networks:

- Wi-Fi/WLAN 802.11 a/b/g/n/ac (2.4 GHz & 5 GHz)
- Bluetooth 4.1

Streaming technologies:

- Chromecast built-in
- Apple AirPlay
- Bluetooth Audio Streaming
- DLNA – DMR
- Spotify Connect
- QPlay 2.0 (China specific)

Supported Audio Formats:

MP3, WMA, AAC, ALAC, FLAC, WAV, AIFF
Standard sample rates up to 192 kHz, stereo and up to 24 bit
Note: WMA lossless is not supported

Connectors:

- 1 x USB-C (for power via external power supply)
- 1 x Power Link socket (RJ45) with two channels
- 1 x Line-in (analogue & digital combo) with sensing
- 1 x Ethernet
- 1 x Optical out - digital sound out (for connection to the BeoSound Shape)
- 1 x USB (for connection to the BeoSound Shape)
- 1 x Digital Power Link (for future use)

Remote Control options:

- Bang & Olufsen app
- BeoSound Essence Remote. BeoSound Core can be paired wirelessly (Bluetooth Low Energy) with the BeoSound Essence Remote. You can have up to five BeoSound Essence Remotes connected to one system.

Connection specifications

OPTICAL

Optical socket - for Audio input
S/P-DIF



USB

USB B Audio 2.0 for Audio input and ServiceTool

- Pin 1 +5VDC
- Pin 2 Data -
- Pin 3 Data +
- Pin 4 GND

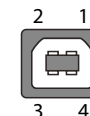

COMM IN

RJ45 - used for amplifier input

- Pin 1 A2B_AP
- Pin 2 A2B_AN
- Pin 3 Signal GND
- Pin 4 Signal GND
- Pin 5 Signal GND
- Pin 6 Signal GND
- Pin 7 Data RX
- Pin 8 Data TX

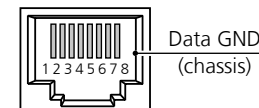

COMM OUT

RJ45 - used for amplifier output

- Pin 1 A2B_BP
- Pin 2 A2B_BN
- Pin 3 Signal GND
- Pin 4 Signal GND
- Pin 5 Signal GND
- Pin 6 Signal GND
- Pin 7 Data TX
- Pin 8 Data RX

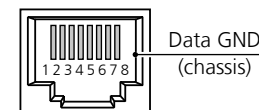

POWER LINK

RJ45 - used for Power Link 1 and 2

- Pin 1 Not used
- Pin 2 Not used
- Pin 3 Signal GND
- Pin 4 Speaker On/Off On => 2.5V, Off =< 0.5V
- Pin 5 Not used
- Pin 6 Audio R out 0V - 6.5V RMS
- Pin 7 Signal GND
- Pin 8 Audio L out 0V - 6.5V RMS

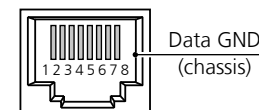

~ 100 - 240 V, 50/60Hz

C8 socket - Mains inlet - To see the different types of mains leads, see exploded view in the Retail Ordering System

Live
Neutral



Table of Contents

Introduction.....	2	BeoSound Shape with BeoLab 19.....	27
How to use this installation guide	3	Stereo setup - Left & Right	29
How to upgrade an existing BeoSound Shape.....	3	Software update.....	34
Navigation in this guide.....	4	How to see the software version.....	34
Navigation TIP	4	Automatic software update	35
BeoSound Shape.....	5	Troubleshooting	37
What is in the package?.....	5	How to reinstall the setup	37
Connection panel	6	Power cycle - Amplifier	37
Mounting	7	How to factory reset the BeoSound Shape amplifier tile.....	38
Placement Tool	7	LED indications	39
Placement conditions	8	Technical specifications	40
Mounting star rails	9	Connectivity (provided by BeoSound Core).....	42
Placement of the wall socket.....	12	Connection specifications	43
Mounting Bang & Olufsen logo badge.....	16	Table of Contents	44
Mounting the tiles.....	17		
Connecting cables	18		
Multiple amplifier setup	20		
First-time setup.....	21		
Mount fabric cover.....	22		
Mount wood cover	24		
How to upgrade an existing BeoSound Shape with more tiles.....	25		
Alternative setup.....	26		
'Band on the wall' without BeoSound Core	26		